

namco[®]

TEKKEN 5

DX -33"



OPERATORS MANUAL

IT IS THE RESPONSIBILITY OF THE OPERATOR TO MAINTAIN CUSTOMER SAFETY
AT ALL TIMES, AND IT IS IMPERATIVE THAT THE DETAILS SET OUT IN THIS MANUAL
ARE FOLLOWED PRECISELY

NOTICE

MAGICGATE is a term to describe a copyright protection technology created by Sony Group. This **MAGICGATE** mark does not necessarily guarantee compatibility with other products bearing the “MagicGate” trademark.

MAGICGATE is a trademark of Sony Corporation.

MAGICGATE est une terme décrivant une technique de protection de copyright créé par Sony Group. **MAGICGATE** ne garantit pas nécessairement de compatibilité avec d'autres produits portant la marque de commerce “MagicGate”

MAGICGATE est une marque de commerce de Sony Corporation.

The DVD-ROM DISC supplied with the product must not be copied, modified, distributed, or used for the purposes other than the operation of the product. Copyright laws protect the contents of the DVD-ROM DISC. Infringement of copyright laws may be subject to criminal penalties.

Do not use the supplied DVD-ROM DISC with other product models or other media formats. Doing so may result in equipment failure.

Contents

OPERATORS MANUAL	1
GENERAL SAFETY CONSIDERATIONS	4
ALLGEMEINE SICHERHEITSHINWEISE	6
GENERELLE SIKKERHEDSOVERVEJELSER	8
CONSIDERACIONES GENERALES DE SEGURIDAD	10
CONSIGNES GENERALES DE SECURITE	12
ΕΞΕΤΑΣΗ ΓΕΝΙΚΗΣ ΑΣΦΑΛΕΙΑΣ	14
CONSIDERAZIONI GENERALI SULLA SICUREZZA	16
VANLIGE SIKKERHETSTILTAK	18
ALGEMENE VEILIGHEIDSOVERWEGINGEN	20
AVISOS DE PERIGO	22
ALLMÄNNA SÄKERHETSBEAKTANDEN	24
YLEISET TURVALLISUUNÄKÖKODAT	26
1. SPECIFICATIONS	28
2. MAIN COMPONENTS	29
3. INSTALLATION	30
3-1 Joining the Play Panel and Monitor Cabinets	30
3-2 Fitting the Play Panel	31
3-3 Fitting the Pop Header	32
3-4 Adjusting the Level Adjusters	32
3-5 Installing the Cards	34
3-6 Installing the CD-ROM	35
4. ADJUSTMENTS AND SETTINGS	36
4-1 Option Switches	36
4-2 Test Mode	37
4-2-1 Display Test	39
4-2-2 Colour Edit	39
4-2-3 Convergence	39
4-2-4 Input Test	40
4-2-5 Game Options	41
4-2-6 Coin Options	43
4-2-7 Sound Test	44
4-2-8 JVS Status	44
4-2-9 Bookkeeping	45
4-2-10 Data Clear	47
4-2-11 Card options	48
4-2-12 Close Setting	51
5. MAINTENANCE AND ADJUSTMENTS	53
5-1 Replacing the Push Button Switch	53
5-2 Replacing the Joystick Assy	54
6. PARTS	56



No part of this publication may be reproduced by any mechanical, photographic or electronic process, or in the form of phonographic recording, nor may it be stored in a retrieval system, transmitted or otherwise copied for private use, without permission from **NAMCO EUROPE LIMITED**.

While the information contained in this manual is given in good faith and was accurate at the time of printing, NAMCO EUROPE LIMITED reserve the right to make changes and alterations without notice.

This equipment has been manufactured in accordance with European Directives, and has been tested and complies with the directives 89/336/EEC and 72/23/EEC by the application of EN55014-1, EN55014-2 and EN60335-2-82 standards and as such bears the CE marking. Any changes or modifications to this equipment must be in accordance with the European Directives. Any unauthorised changes to this equipment may contravene such directives.

Under some conditions of extreme external interference, e.g. radio transmissions, electrostatic discharge or mains born transients, some degradation of performance may occur. However the equipment will recover normal performance once the source of interference has ceased or been removed.

Following abnormally high surges on the mains supply, the video monitor may need to be manually reset by turning the equipment OFF and back ON.

If the game processor resets due to an interruption of the mains voltage, any credits established will be lost.

This equipment is not a machine as defined by the machinery directive 89/392/EEC.

SAFETY WARNING

In order to use this equipment safely, be sure to read this Operators Manual carefully before installation, adjustment or use of this equipment.

Whenever the owner of this equipment entrusts dis-assembly, installation, adjustment or routine maintenance to another person, the owner should ensure that that person read the appropriate precautions and relevant sections of this manual before starting work.

In order that no accidents occur when the equipment is in operation, strictly follow the notes on safety as described below.

This manual along with the Installation Manual (where applicable) form an integral part of the equipment and must be available to the operating or service personnel at all times.

This equipment is for indoor use only and should only be used for the purpose intended.

Namco Europe Ltd. bears no responsibility for accidents, injury or damage resulting from unauthorized changes to, or improper use of this equipment.









SAFETY NOTES

The following safety notes are used throughout this manual. Familiarize yourself with each of these notes and it's meaning before installing, servicing or making adjustments to this equipment.

WARNING  Warning denotes a hazard that could result in injury or death. Do not proceed beyond a warning note until the indicated conditions are fully understood and met.

CAUTION  Caution denotes a hazard that could result in damage to the equipment. Do not proceed beyond a caution note until the indicated conditions are fully understood and met.

GENERAL SAFETY CONSIDERATIONS

-  **Only operate this equipment after checking that it has been installed correctly and in accordance with this manual.**
-  **The warning notices must always be kept in good condition and replaced if worn, so that customers can read them clearly.**
-  **Installation, service, adjustment or routine maintenance should be carried out by suitably qualified persons only.**
-  **For continued protection against fire hazard, replace fuses with the same type and rating. The use of other fuses or material is prohibited.**
-  **The power supply inside the monitor will remain hot and have areas of high voltage even though the equipment has been tuned OFF, and there is the possibility of burns or electric shock. Be careful not to touch these areas.**
-  **To prevent possible electric shock due to failure, this equipment **MUST** be fitted with a securely connected **EARTHED** plug.**
-  **If at any time the mains lead becomes damaged, it must be replaced immediately.**
-  **Do not turn the power switch ON until the equipment has ben installed correctly.**
-  Before connecting the machine to the mains supply, ensure that the equipment is set for the correct voltage and that the correct fuses are fitted.

NOTES ON INSTALLATION



NEVER turn the power to the machine **ON** until installation has been completed.



In order to prevent possible electric shocks, be sure that the equipment is connected to the mains with a securely connected earthed plug.



In order to avoid damage to the equipment due to mis-operation, ensure that the voltage of the mains supply is 230volts AC.

Note: If the location of this equipment has a polished floor, it is recommended that rubber pads are fitted under the level adjusters to prevent the equipment sliding on the floor when in use.

Note: In order to gain access to the Power Supply and CPU assemblies, ensure that the rear of the equipment is separated from a wall or other equipment by at least 500mm

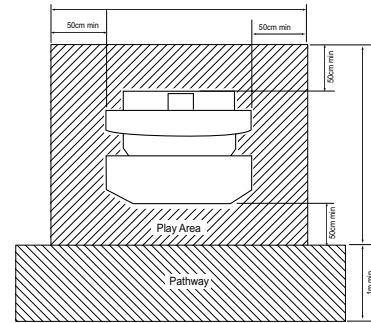

MOVING THE EQUIPMENT



This equipment is fitted with castors to make it easier to move. Take care when moving the equipment on an inclined surface.



The overall height of the equipment , with the Header Assembly fitted, is 1940mm. Take care of any overhead obstructions. (e.g. Light Fittings, Electric Cables etc.)

REMOVING AND REPLACING PARTS



Adjustments or maintenance on this equipment should be carried out by suitably qualified personnel only.



Do not make any alteration to this equipment without prior approval. Doing so could cause unforeseeable danger.



Only parts specified by Namco Europe Ltd. should be used when replacing parts. (Including screws)



Ensure that the power to the equipment is turned OFF before commencing any maintenance work. (Trouble shooting, repairs etc.)



If performing work not described in this manual, contact your distributor for instructions, as no responsibility will be accepted for damage or injury.



Parts of the Power Supply and Monitor remain hot and carry high voltage even after switching OFF and could cause burns or electric shock. Take care not to touch these parts accidentally.



Make sure that the equipment is switched OFF before connecting or disconnecting any plugs or connectors.



When moving the mains connector from the equipment, or the mains plug from the wall outlet, always grasp the plug and not the cable.



Dieses Dokument darf in keiner Weise vervielfältigt werden. Jegliche Tonaufnahmen sowie die Speicherung auf Datenträger (Suchsysteme), die Weitergabe oder sonstiges Kopieren für den gewerblichen und privaten Gebrauch sind untersagt und bedürfen der vorherigen Genehmigung durch NAMCO EUROPE LIMITED.

Die Informationen in diesem Handbuch entsprechen den Tatsachen bei Drucklegung. NAMCO EUROPE LIMITED behält sich jedoch das Recht zu Änderungen ohne vorherige Bekanntgabe vor.

Dieses Gerät trägt das CE-Zeichen und wurde gemäß den EU-Richtlinien produziert. Es erfüllt die Richtlinien 89/336/EEC und 72/23/EEC und Standards EN 55014-1, EN55014-2 und EN60335-2-82 (s. Deckblatt des Handbuchs). Alle Veränderungen an diesem Gerät müssen in Übereinstimmung mit den EU-Richtlinien erfolgen. Nicht genehmigte Veränderungen an diesem Gerät verstoßen gegen diese Richtlinien.

Extreme äußere Störungen, wie z.B. durch Radiobetrieb, elektrostatische Entladung oder zeitweilige Netzschwankungen können zu einer Leistungsminderung führen. Sobald diese Faktoren jedoch ausgeschaltet oder beseitigt wurden, erreicht das Gerät seine normale Leistung.

Achtung! Falls der Spielprozessor auf Grund von Netzunterbrechungen oder Abnahme der Netzspannung aussetzt, kann es zum Verlust von Spielkrediten kommen.

Dieses Gerät fällt nicht unter die Maschinen-Richtlinie 89/392/EEC

SICHERHEITSHINWEISE

Um einen ordnungsgemäßen Betrieb dieses Gerätes zu gewährleisten, muß vor Aufstellung, Inbetriebnahme und Gebrauch das Handbuch sorgfältig gelesen werden.

Sobald der Besitzer dieses Gerätes die Demontage, Aufstellung, Inbetriebnahme oder den Service einer anderen Person überträgt, muß er sicherstellen, daß diese Person vor Arbeitsbeginn die nötigen Sicherheitshinweise und die dazugehörigen Kapitel des Handbuchs liest und versteht.

Um jegliche Unfälle während des Betriebes zu vermeiden, müssen obige Hinweise strikt befolgt werden.

Dieses Handbuch sowie das spezielle Geräte-Handbuch (wenn vorhanden) gehören zum Gerät und müssen dem Betreiber und Wartungspersonal stets zugänglich sein

Dieses Gerät ist ausschließlich für den gewerblichen Gebrauch in geschlossenen Räumen bestimmt und darf nur dort betrieben werden.

NAMCO EUROPE Ltd. übernimmt keinerlei Haftung für Unfälle, Verletzungen oder Beschädigungen, die auf nicht genehmigte Veränderungen oder unsachgemäßen Betrieb des Gerätes zurückzuführen sind.

SICHERHEITSHINWEISE

Folgende Sicherheitsbegriffe werden im gesamten Handbuch benutzt. Machen Sie sich daher bitte vor Inbetriebnahme, Wartung und Durchführung von Einstellungen am Gerät mit diesen Warnhinweisen vertraut.

WARNUNG  **WARNUNG** bezeichnet eine Gefahrenquelle für Leib und Leben. Erscheint dieser Warnhinweis, darf erst weitergearbeitet werden, wenn die entsprechenden Erklärungen vollständig verstanden und befolgt wurden.

VORSICHT  **VORSICHT** bezeichnet eine Gefahrenquelle für die Beschädigung des Gerätes. Erscheint dieser Warnhinweis, darf erst weitergearbeitet werden, wenn die entsprechenden Erklärungen vollständig verstanden und befolgt wurden.

ALLGEMEINE SICHERHEITSHINWEISE



Das Gerät darf nur betrieben werden, nachdem es vorschriftsmäßig und in Übereinstimmung mit dem Handbuch aufgestellt wurde.



Die Warnschilder müssen in gutem Zustand sein und ersetzt werden, wenn sie nicht mehr gut lesbar sind.



Aufstellung, Service, Einstellungen und Wartung dürfen nur von dafür qualifiziertem Fachpersonal durchgeführt werden.



Zur Vermeidung von Feuer, defekte Sicherungen nur durch vorgeschriebene Sicherungen ersetzen. Die Verwendung von andersartigen Sicherungen oder unterschiedlichem Material ist untersagt.



Das Netzteil im Monitor bleibt nach Ausschalten des Gerätes noch heiß und führt weiterhin Hochspannung. Daher besteht die Gefahr von Verbrennungen und Elektroschlägen. Diese Bereiche dürfen nicht berührt werden.



Zur Vermeidung von Elektroschlägen muß dieses Gerät mit einem ordnungsgemäß geerdeten Netzstecker versehen sein.



Bei Beschädigungen des Netzteiles muß dieses umgehend ersetzt werden.



Gerät erst nach abgeschlossener Aufstellung einschalten.



Vor Einstecken des Netzsteckers bitte sicherstellen, daß Netzspannung und Gerätespannung übereinstimmen, und die vorgeschriebenen Sicherungen verwendet wurden.

HINWEISE ZUR AUFSTELLUNG



NIEMALS das Gerät einschalten bevor die Aufstellung völlig abgeschlossen ist.



Zur Vermeidung von Elektroschlägen muß das Gerät mit einem ordnungsgemäß geerdetem Netzstecker an die Stromversorgung angeschlossen werden.



Zur Vermeidung von Beschädigungen durch Fehlbetrieb am Gerät sicherstellen, daß die Netzspannung 230 Volt beträgt.

Hinweis: Ist das Gerät für einen Aufstellplatz mit glattem Fußboden bestimmt, müssen die Standbeine mit Gummiplättchen unterlegt werden, damit das Gerät fest steht und nicht auf dem Boden hin- und herrutscht.

Hinweis: Zu Reparaturzwecken am Netzteil und den CPU-Komponenten muß die Rückseite des Gerätes mindestens 50cm von anderen Geräten und der Wand entfernt sein.

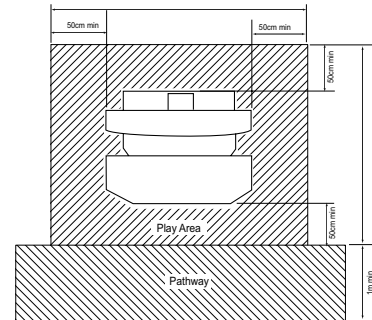

Zum leichteren Transport ist das Gerät mit Rollen ausgerüstet. Daher besondere Vorsicht auf abschüssigem Boden



Die Gesamthöhe de Gerätes beträgt 1.94m. Daher Vorsicht bei tiefer hängenden Beleuchtungskörpern.

AUS- UND EINBAU VON KOMPONENTEN UND TEILEN



Aufstellung, Service, Einstellung und Wartung dürfen nur von dafür qualifiziertem Fachpersonal durchgeführt werden.



Es dürfen keierlei Veränderungen ohne vorherige Genehmigung am Gerät vorgenommen werden. Zuwiderhandlungen stellen eine Gefahrenquelle dar.



Für die Repartur dürfen nur Originalersatzteile (incl. Schrauben) von NAMCO EUROPE LTD. verwendet werden.



Vor Beginn aller Wartungsarbeiten (Fehlersuche, Reparaturen etc.) muß der Netzstecker gezogen werden.



Bei Arbeiten, die nicht in diesem Handbuch beschrieben werden, muß vorher der Händler zu Rate gezogen werden, da sonst keinerlei Haftung bei Beschädigungen und Verletzungen übernommen wird.



Teile des Netzteiles und Bilschirmes bleiben nach Abschalten noch heiß und führen Hochspannung. Dies kann zu Verbrennungen oder einem Elektroschlag führen. Diese Teile dürfen nich berührt werden.



Vor der Montage oder dem Entfernen von Steckverbindungen und Steckern muß das Gerät ausgeschaltet werden.



Bei Ziehen des Gerätesteckers oder des Netzsteckers aus der Wandsteckdose stets den Stecker greifen und nicht das Kabel.



Denne udgivelse må ikke reproducere af nogen som helst mekanisk, fotografisk eller elektrisk proces eller i form af indspilning, den må heller ikke lagres i et eftersøgningssystem transmitteres eller kopieres til nogen form for offentlig benyttelse uden tilladelse fra **Namco Europe Limited**.

Da informationerne i denne manual er givet med god tro og var korrekt på udskivningstidspunktet, forbeholder Namco Europe Limited sig retten til, at foretage ændringer og forandringer uden varsel.

Denne maskine er fremstillet i overensstemmelse med Det Europæiske fællesskabs direktiver og er blevet testet og fuldendt med direktiverne 89/336/EEC og 72/23/EEC standarder (se manualens forside) og som sådan bærer CE mærket. Enhver form for ændring eller modifikation af denne maskine skal være i overensstemmelse med Det Europæiske fællesskabs direktiver.

I tilfælde af forbigående ekstreme eksterne forstyrrelser, så som radio udsendelser, elektronisk afgivelse eller forstyrrelser på ledningsnettet, kan nedbrydning forekomme. Maskinen vil dog køre normalt så snart forstyrrelsen ophører eller bliver fjernet.

Bemærk:- Hvis spilleprocessoren resetter p.g.a. en forstyrrelse eller reduktion af hovedstrømmen kan de etablerede kreditter gå tabt.

Dette spil er ikke en maskine defineret af maskin direktivet 89/392/EEC -

SIKKERHEDS ADVARSEL

For at betjene denne maskine sikkert, læs da denne brugemanual grundigt før installation, justering eller brug af maskinen. Når som helst ejeren af denne maskine overlader demontering, installation, justeringer eller daglig vedligehold til en anden person, skal ejeren sikre sig at denne person læser de sikkerhedsregler og relevante punkter i denne manual før arbejdet begynder. For at undgå ulykker når maskinen er i gang, følg nøje de sikkerhedsregler der er beskrevet herunder. Denne manual sammen med installations manualen er en uløselig del af udstyret og skal altid være til rådighed for det arbejdende og servicerende personale. Denne maskine er kun til indendørs brug og bør kun bruges til det beregnede formål. Namco Ltd. bærer intet ansvar for ulykker eller skader som er et resultat af uautoriserede ændringer eller fejlagtig brug af denne maskine.









SIKKERHEDSREGLER

De følgende sikkerhedsregler er brugt helt igennem denne manual. Gør dig bekendt med hver enkelt af dem og meningen heraf før installation, servicering eller justering af denne maskine.

ADVARSEL  Advarsel betegner en episode der kan resultere i skader eller død. Begiv dig ikke forbi et advarselsskilt før de indikerede betingelser er fuldstændig forstået.

FORSIGTIG  Forsigtig betegner en episode der kan resultere i ødelæggelse af maskinen. Begiv dig ikke forbi et advarselsskilt før de indikerede betingelser er fuldstændig forstået.

GENERELLE SIKKERHEDSOVERVEJELSER

-  **Betjen kun maskinen efter at have tjekket, at den er korrekt installeret og er i overensstemmelse med manualen.**
-  **Advarselsskiltene skal altid være i god stand og erstattes hvis de er slidt, så kunden tydeligt kan læse dem.**
-  **Installations service, justeringer eller daglig vedligehold bør kun udføres af en kvalificeret person.**
-  **For fortsat beskyttelse mod brandfare, sikres at hoved sikringerne kun erstattes med samme type kapacitet. Brug af anden kapacitet eller materiale er forbudt.**
-  **Strømforsyningen inde i monitoren vil forblive varm og have områder med høj spænding selvom maskinen har været slukket og der er fare for brandskader eller elektrisk stød. Pas på med at røre disse områder.**
-  **For at undgå elektrisk stød p.g.a. en fejl skal denne maskine være forbundet med et sikkert jordstik.**
-  **Hvis hoved ledningerne på noget tidspunkt bliver beskadiget skal de strakt erstattes.**
-  **Tænd ikke for strømmen før maskinen er korrekt installeret.**
-  **Før tilslutning af maskinen til hovedstrømmen sikres, at maskinen er indstillet til den rette spænding.**

PUNKTER OM INSTALLATION



Tænd aldrig for strømmen til maskinen før installation er fuldført.



For at undgå mulige elektriske stød sikres, at maskinen er forbundet til hovedstrømmen med sikkert monterede jordstik.



For at undgå skader på maskinen p.g.a. fejlbetjening sikres, at spændingen på hovedstrømmen er 230 volt AC.

BEMÆRK : Hvis denne maskine placeres på et poleret gulv, anbefales det at ligge gummimåtter under justeringsfødderne for at undgå at maskinen glider på gulvet.

BEMÆRK : For at få adgang til strømforsyningen og CPU justeringer sikres, at bagsiden af hoved kabinettet står adskilt fra andre maskiner eller væggen med mindst 50cm.

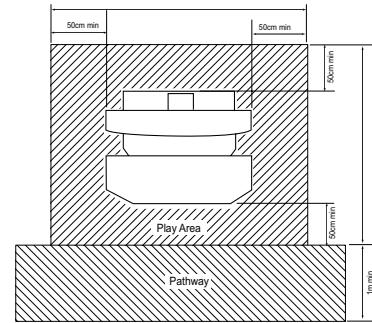

Maskinen er smurt med olie for at gøre den lettere bevægelig. Pas på når maskinen flyttes på en skrå overflade.



Den fulde højde af hoved sektionen er 1.94m. Pas på øvre forhindringer f.eks. lys inventar

AT FJERNE OG UDSKIFTE SEKTIONER OG DELE.



Justeringer eller vedligehold af denne maskine bør kun udføres af kvalificeret personale.



Skift ikke noget på maskinen uden godkendelse, det kan føre til uforudset fare.



Der bør kun bruges dele specificeret af Namco Europe Limited når der skiftes eller repareres dele (inklusive skruer).



Sørg for, at strømmen til maskinen er slukket før der foretages nogen form for arbejde (fejlfinding, reparation etc.)



Hvis der foretages arbejde der ikke er beskrevet i denne manual, kontakt da din leverandør for at få kyndig vejledning, da intet ansvar vil blive accepteret ved skader.



Dele af strømforsyningen og monitoren forbliver varme eller bærer høj spænding selv efter maskinen er slukket, det kan føre til forbrændinger eller elektriske stød. Pas på ikke at røre disse dele ved et uheld.



Læg mærke til at maskinen er slukket før samlinger eller stik tages ud eller sættes i.



Når hovedsamlingen fjernes fra maskinen eller hovedstikket fjernes fra væggen, tag da altid ved stikket, ikke ledningen.



No se permite la reproducción total ni parcial de esta publicación por ningún medio mecánico, fotográfico o electrónico, grabaciones fonográficas, ni su almacenamiento informático, su transmisión o su copia, ya sea para uso público o privado, sin permiso de NAMCO EUROPE LIMITED.

Si bien la información contenida en este manual se da de buena fe y es correcta en el momento de su impresión, NAMCO EUROPE LIMITED se reserva el derecho de hacer cambios y alteraciones sin previo aviso.

Esta máquina ha sido fabricada según las directrices de la Comunidad Europea, ha sido probada, y se ajusta a las directrices 89/336/EEC y 72/23/EEC, mediante la aplicación de los estándares EN55014-1, EN55014-2 y EN60335-2-82 (véase cubierta del manual) y por ende lleva el sello de la C.E. Cualquier cambio o modificación que se haga a esta máquina ha de ajustarse a las directrices de la Comunidad Europea. Cualquier cambio no autorizado hecho al producto pudiera contravenir estas directrices.

Bajo ciertas condiciones de extrema interferencia externa, p. ej. transmisiones de radio, descargas electrostáticas u oscilaciones de la red eléctrica puede tener lugar un descenso del rendimiento. No obstante, la máquina recuperará su rendimiento normal una vez que la fuente de interferencias sea retirada o cese de producirlas.

Nota: Si el procesador de juegos se reinicializa a causa de caídas o interrupciones en la alimentación eléctrica, se perderán todos los créditos.

Este juego no se ajusta a la definición de máquina de la Normativa de Maquinaria 89/392/EEC

AVISOS DE SEGURIDAD.

Para utilizar esta máquina con seguridad, lea cuidadosamente este Manual de Operador antes de proceder a la instalación, ajuste o uso de esta máquina.

Cada vez que el propietario de esta máquina confíe a terceros su desmontaje, instalación, ajuste o mantenimiento rutinario deberá asegurarse de que tales personas lean las precauciones adecuadas y las secciones relevantes de este manual antes de comenzar su trabajo.

Para que no ocurra accidente alguno mientras la máquina se encuentre en funcionamiento, siga estrictamente las notas de seguridad tal como más adelante se describen.

Este manual, junto con el Manual de Instalación (cuando proceda), forma parte integral del equipo y debe estar a disposición del personal de mantenimiento y operación en todo momento.

Esta máquina es únicamente para ser usada en interiores, y sólo debe usarse para aquello para lo que ha sido creada.

Namco Ltd. queda exenta de cualquier responsabilidad por accidentes, heridas o daños causados por cambios no autorizados o uso indebido de esta máquina.









NOTAS DE SEGURIDAD.

En este manual se usan las notas siguientes. Familiarícese con cada una de ellas y su significado antes de instalar, revisar, o hacer ajustes en esta máquina.

AVISO.  **Aviso señala un riesgo que puede ocasionar lesiones o la muerte. Tras ver esta nota, no continúe hasta entender completamente y cumplir las condiciones exigidas.**

PRECAUCIÓN.  **Precaución señala un riesgo que puede ocasionar daños a la máquina. Tras ver esta nota, no continúe hasta entender completamente y cumplir las condiciones exigidas.**

CONSIDERACIONES GENERALES DE SEGURIDAD.

-  **Opere sólo con esta máquina tras comprobar que ha sido instalada correctamente y de acuerdo con este manual.**
-  **Las notas de aviso deben mantenerse siempre en buen estado y reemplazarse si estuvieran desgastadas para que los usuarios puedan leerlas con claridad.**
-  **Las revisiones de instalación, los ajustes, y el mantenimiento rutinario deberán llevarse a cabo sólo por personal cualificado.**
-  **Para asegurar una continua protección contra riesgo de incendios, asegúrese de que los fusibles eléctricos sean reemplazados solamente por otros del mismo tipo y especificaciones. El uso de otros fusibles o material está prohibido.**
-  **La fuente de alimentación del monitor se mantiene caliente, y tiene zonas de alto voltaje incluso cuando la máquina ha sido desconectada, existiendo el riesgo de quemaduras y descargas eléctricas. Tenga cuidado de no tocar estas zonas.**
-  **Para evitar posibles descargas eléctricas por cortes, esta máquina debe estar provista de un enchufe debidamente conectado, con TOMA DE TIERRA.**
-  **Si en cualquier momento el cable de alimentación se dañara, deberá ser reemplazado inmediatamente.**
-  **No encienda el interruptor de la máquina hasta que ésta haya sido correctamente instalada.**
-  **Antes de enchufar la máquina a la red eléctrica, asegúrese de que la máquina está preparada para el voltaje correcto, y de que se usan los fusibles adecuados.**

NOTAS DE INSTALACIÓN.



JAMÁS ENCIENDA la máquina antes de haber completado la instalación.



Para evitar posibles descargas eléctricas, asegúrese de que la máquina está conectada a la red con un enchufe provisto de toma de tierra.



Para evitar daños a la máquina causados por operación incorrecta, asegúrese de que el voltaje de la red es de 230 voltios, corriente alterna.

Notas : Si el lugar donde se instalará la máquina tiene un piso pulido, se recomienda colocar tacos de goma bajo los ajustadores de nivel para evitar que la máquina se deslice por el suelo.

Notas : Para acceder a las unidades de Fuente de Alimentación y CPU, asegúrese de que la parte trasera del mueble principal está separada de muros u otras máquinas al menos 500 mm.

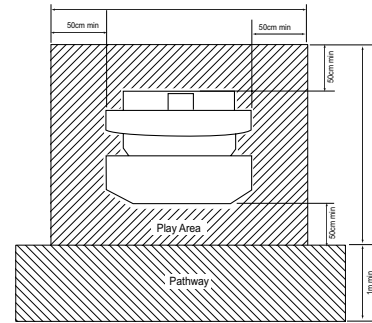

El juego tiene ruedecitas para hacer más fácil su traslado. Tenga cuidado al mover la máquina en una superficie inclinada.



La altura total de la Unidad principal es de 1.94mm. Tenga cuidado de que no haya obstáculos p. ej. luces.

RETIRAR Y REEMPLAZAR PARTES Y UNIDADES.



Las revisiones de instalación, los ajustes, y el mantenimiento rutinario deberán llevarse a cabo sólo por personal cualificado.



No realice alteraciones en esta máquina sin aprobación previa. De hacerlo así, pueden causar peligros imprevisibles.



Sólo deben usarse las partes especificadas por Namco Europe Ltd. para reparaciones o reemplazos (incluidos los tornillos).



Asegúrese de que la máquina está desconectada antes de comenzar cualquier trabajo de mantenimiento (reparaciones, resolución de problemas, etc.)



Al realizar trabajos no descritos en este manual, póngase en contacto con su distribuidor para recibir instrucciones. Se declina cualquier responsabilidad por daños o lesiones.



Hay partes de la fuente de alimentación y del monitor que se mantienen calientes o almacenan alto voltaje incluso tras desconectar la máquina, y pueden producir quemaduras o descargas eléctricas. Tenga cuidado de no tocar accidentalmente estas partes.



Asegúrese de que la máquina está apagada antes de conectar o desconectar cualquier enchufe o conector.



Al retirar el conector principal de la máquina, o la clavija de alimentación del enchufe de la red, agarre siempre la clavija y no el cable.



Aucun élément de cette publication ne sera reproduit, ni par procédé mécanique, photographique ou électronique, ni par un moyen d'enregistrement phonographique. Ces informations ne seront ni stockées grâce à un procédé de récupération, ni transmises ou autrement copiées pour un usage public ou privé, sans l'autorisation de **NAMCO EUROPE LIMITED**.

Malgré le fait que les informations contenues dans ce manuel soient données de bonne foi et étaient actualisées au moment de leur impression, NAMCO EUROPE LIMITED se réserve le droit de procéder à des changements ou à des modifications sans avis préliminaire.

Ce jeu a été fabriqué en respect des normes de la Communauté Européenne, après avoir été testé il répond aux normes 89/336/EEC et 72/23/EEC, en application des standards EN55014-1, EN55014-2 et EN60335-2-82 (voir la couverture du manuel), et comme tel il comporte l'autocollant de conformité avec les normes de la Communauté Européenne. Tout changement non autorisé sur ce produit pourrait contrevenir à ces normes.

Sous certaines conditions extrêmes d'interférence externe, par exemple des transmissions radio, des décharges électrostatiques ou bien de interférences passagères sur le réseau, certaines dégradations ou anomalies peuvent se produire. Le jeu retrouvera cependant son état normal de fonctionnement lorsque la cause de ces anomalies aura cessé ou se trouvera déplacée.

Note:-

Si le processeur du jeu se reprogramme suite à une interruption ou une réduction de l'alimentation, les crédits qu'il aurait pu contenir peuvent se trouver perdus.

Ce jeu n'est pas une machine, telle que définie par la norme sur les machines 89/392/EEC

MESURES DE SECURITE

Afin d'utiliser ce jeu en toute sécurité, bien lire ce manuel d'utilisation avant de procéder à son installation, son réglage ou son exploitation.

Si le propriétaire de ce jeu en confie le démontage, l'installation, le réglage ou la maintenance habituelle à une autre personne, il devra s'assurer que cette personne ait lu les conseils d'utilisation et les passages du manuel se rapportant à ce thème, avant qu'elle ne commence son travail.

Afin d'éviter tout accident pendant la durée d'exploitation de ce jeu, se conformer strictement aux conseils de sécurité décrits à la suite.

Ce manuel ainsi que le manuel d'installation du jeu (là où nécessaire) font partie des éléments nécessaires à l'installation de la machine et doivent être mis à la disposition de l'utilisateur et du personnel de maintenance à tout moment.

Ce jeu est uniquement destiné à un usage intérieur et devra être utilisé comme tel.

Namco Ltd. ne sera aucunement tenu responsable en cas d'accidents, de blessure ou de dommage quelconque résultant de modifications non autorisées ou d'usage impropre du jeu.

REMARQUES SUR LA SECURITE

Les termes de sécurité détaillés à la suite seront utilisés tout au long de la lecture de ce manuel. Il convient de vous familiariser avec chacun de ces termes ainsi que leur signification avant de procéder à l'installation, à la maintenance ou au réglage du jeu.

AVERTISSEMENT



Ce terme annonce un danger qui pourrait éventuellement avoir des conséquences dommageables ou mortelles. Ne pas passer outre ce signal jusqu'à ce que les conditions indiquées soient entièrement comprises et effectuées.

ATTENTION



Ce terme indique qu'un danger menace la machine. Ne pas passer outre ce signal jusqu'à ce que les conditions indiquées soient entièrement comprises et effectuées.

CONSIGNES GENERALES DE SECURITE



Allumer l'appareil seulement après avoir vérifié qu'il a été correctement installé, et que les instructions du manuel ont été respectées.



Les notes de mise en garde doivent constamment demeurer en bon état et être remplacées en cas de disparition, afin que le client puisse les lire clairement.



L'installation, le service, le réglage, ou la maintenance doivent être effectués uniquement par les personnes qualifiées.



Afin d'éviter un éventuel incendie, s'assurer que les fusibles soient remplacés par le même type de fusibles et au bon voltage. L'utilisation d'autres sortes de fusibles ou autres matériels est interdite.



L'alimentation à l'intérieur du moniteur reste chaude et comporte des zones de haute tension même si la machine est éteinte. Il existe donc un risque de brûlure ou d'électrocution. Attention à ne pas toucher ces endroits.



Pour prévenir une éventuelle électrocution due à un défaut matériel, ce jeu DOIT être muni d'une prise de TERRE connectée en toute sécurité



Si à tout moment les fils électriques sont endommagés, il faut les remplacer immédiatement



Ne pas mettre le jeu en mode de fonctionnement avant qu'il n'ait été correctement installé.



Avant de connecter la machine au réseau, s'assurer que la machine est installée sous la bonne tension et que les fusibles correspondent.

NOTES D'INSTALLATION



NE JAMAIS mettre le jeu en marche avant que l'installation ne soit complètement effectuée.



Afin de prévenir une éventuelle électrocution, s'assurer que la machine est connectée au réseau avec une prise de terre reliée selon les normes de sécurité.



Afin d'éviter que la machine ne soit abîmée suite à une mauvaise opération, s'assurer que la tension sur le réseau principal soit de 230 volts AC.

Note: Si l'endroit où doit être installée la machine à un sol pöli, il est recommandé de poser des tampons feutrés sous les vérins pour éviter que le jeu ne glisse sur le sol

Note: Afin de faciliter l'accès aux CPU et à l'alimentation, s'assurer qu'il y a un espace d'au moins 500 mm entre l'arrière du meuble et le mur ou tout autre jeu.

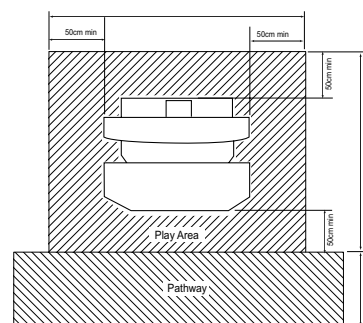

Le jeu est fourni avec des roulettes pour une meilleure mobilité. Prendre garde quand la machine est déplacée sur une surface inclinée.



La hauteur totale de l'assemblage principal est de 1940 mm, prendre garde aux encombrements de la partie supérieure (ex : illuminations du bandeau).

DEPLACER ET REMPLACER LES UNITES ET LES PIECES DETACHEES.



L'installation, le service, le réglage, ou la maintenance doivent être effectués uniquement par les personnes qualifiées.



Ne pas apporter de modifications sur cette machine sans autorisation préalable, faute de quoi cela pourrait entraîner un danger.



Seules les pièces détachées Namco Europe Ltd. doivent être utilisées pour le remplacement ou la réparation de pièces (y compris les vis)



S'assurer que l'interrupteur soit sur OFF avant de commencer tout travail de maintenance (localisation d'une panne, réparations, etc.)



Si dans ce manuel il manque une information pour réaliser un quelconque travail, contacter votre distributeur, car aucune responsabilité ne sera acceptée en cas de dommage ou de blessure.



Les pièces de l'alimentation et du moniteur restent chaudes, à tension élevée même lorsque la machine est hors tension, elle pourrait occasionner des brûlures ou des électrocutions. Attention de ne pas toucher ces endroits accidentellement.



S'assurer que la machine soit hors tension avant de brancher ou débrancher toute prise ou connecteur.



Lorsque l'on manipule la prise au réseau de la machine, ou lorsque les prises principales doivent être débranchées, saisir toujours la prise, et non le câble.



Κανένα μέρος αυτής της έκδοσης δεν μπορεί να αναπαραχθεί με οποιοδήποτε μηχανικό, φωτογραφικό ή ηλεκτρονικό μέσο, ή με μορφή φωνητικής ηχογράφησης και ούτε να αποθηκευτεί με επαναρθρωτικό σύστημα, να μεταδοθεί ή να αντιγραφεί για δημόσια ή ιδιωτική χρήση, χωρίς την άδεια της NAMCO EUROPE LIMITED.

Καθώς αυτές οι πληροφορίες σε αυτό το εγχειρίδιο έχουν δοθεί με καλή πίστη και ακριβώς την ώρα της τύπωσης, η εταιρεία NAMCO EUROPE LIMITED κρατάει το δικαίωμα να κάνει οποιοσδήποτε αλλαγές χωρίς ειδοποίηση.

Τα μηχανήματα έχουν κατασκευαστεί σύμφωνα με τους όρους της Ευρωπαϊκής Κοινότητας, και έχουν ελεγχθεί σύμφωνα με τους νόμους 89/336/ΕΟΚ και 72/23/ΕΟΚ με την αίτηση των EN55014-1, EN55014-2 και EN60335-2-82 στάνταρτς (δες μπροστά στο εγχειρίδιο) και όλα έχουν το CE σήμα. Οποιαδήποτε αλλαγή ή μετατροπή σε αυτό το μηχάνημα πρέπει να είναι σύμφωνα με τους όρους της Ευρωπαϊκής Κοινότητας. Οποιοσδήποτε αλλαγές χωρίς άδεια σε αυτό το προϊόν μπορεί να παραβεί αυτούς τους όρους.

Σε κάποιες περιπτώσεις υπερβολικής εξωτερικής παρεμβολής, π.χ. ραδιοφωνικές μεταδόσεις, ηλεκτροστατικές μεταβολές ή παροδικές εμβολές, μπορεί να παρουσιαστούν κάποιες αθλιότητες στην παρουσίαση. Πάντως το μηχάνημα θα επανέλθει στην φυσιολογική παρουσίαση εφ' όσον η πηγή της παρεμβολής σταματήσει ή απομακρυνθεί.

Σημείωση: Εάν γίνει reset στον processor του μηχανήματος κατά τη διάρκεια της κύριας παροχής, πόντοι που έχουν κερδηθεί μπορεί να χαθούν.

Αυτό το παιχνίδι δεν είναι μηχάνημα όπως προσδιορίζεται από τους όρους Μηχανημάτων 89/392/ΕΟΚ.

ΟΔΗΓΙΕΣ ΑΣΦΑΛΕΙΑΣ

Για την ασφαλή χρήση του μηχανήματος, πρέπει να διαβάσεις το εγχειρίδιο χρήσης προσεκτικά πριν την εγκατάσταση, τοποθέτηση ή χρήση του μηχανήματος.

Οποτεδήποτε ο ιδιοκτήτης αυτού του μηχανήματος ζητάει από κάποιο πρόσωπο να εγκαταστήσει, να κάνει οποιαδήποτε αλλαγή ή έλεγχο ρουτίνας στο μηχάνημα, πρέπει να είναι σίγουρος ότι έχει διαβάσει τις οδηγίες αυτού του εγχειριδίου πριν να αρχίσει να δουλεύει.

Προς αποφυγήν οποιοσδήποτε ατυχήματος κατά την λειτουργία του μηχανήματος, αυστηρώς ακολουθούνται οι οδηγίες ασφάλειας όπως δίνονται παρακάτω.

Αυτό το εγχειρίδιο σε συνδυασμό με το εγχειρίδιο εγκατάστασης (όπου διατίθεται) αποτελεί ένα ολοκληρωμένο μέρος των παροχών και πρέπει να είναι διαθέσιμο για την λειτουργία και το service οποιαδήποτε στιγμή.

Αυτό το μηχάνημα είναι για χρήση μόνο σε εσωτερικό χώρο και θα πρέπει να χρησιμοποιείται μόνο για τους λόγους για τους οποίους κατασκευάστηκε.

Η εταιρεία NAMCO Ltd δεν φέρει καμία ευθύνη για ατυχήματα, πληγές ή καταστροφές που μπορεί να προκληθούν από αλλαγές χωρίς άδεια σε ή εισαγωγείς αυτού του μηχανήματος.

ΣΗΜΕΙΩΣΕΙΣ ΑΣΦΑΛΕΙΑΣ

Οι ακόλουθες σημειώσεις ασφάλειας χρησιμοποιούνται μέσω αυτού του εγχειριδίου. Διάβασε αυτές προσεκτικά για να γίνει κατανοητό το νόημά τους πριν την εγκατάσταση, σέρβις ή οποιαδήποτε αλλαγή γίνει στο μηχάνημα.

ΠΡΟΕΙΔΟΠΟΙΗΣΗ



Η προειδοποίηση αφορά κίνδυνο ο οποίος μπορεί να είναι λόγος θανάτου. Να μην προχωρήσεις σε οποιαδήποτε κίνηση μέχρι αυτοί οι όροι γίνουν κατανοητοί.

ΠΡΟΣΟΧΗ



Η προσοχή αφορά κίνδυνο ο οποίος μπορεί να προκαλέσει πρόβλημα στο μηχάνημα. Να μην προχωρήσεις σε οποιαδήποτε κίνηση μέχρι αυτοί οι όροι γίνουν κατανοητοί.

ΕΞΕΤΑΣΗ ΓΕΝΙΚΗΣ ΑΣΦΑΛΕΙΑΣ



Αφού έχει κατανοηθεί αυτό το εγχειρίδιο, μόνο τότε να λειτουργήσει το μηχάνημα ή να γίνει έλεγχος εφ' όσον έχει γίνει η εγκατάσταση.



Οι προειδοποιήσεις πρέπει να μένουν καθαρές και σε καλή κατάσταση ώστε ο πελάτης να τις διαβάζει καθαρά.



Εγκατάσταση, μετατροπή ή έλεγχος ρουτίνας μπορεί να γίνεται μόνο από εξουσιοδοτημένα άτομα.



Για συνεχή προστασία από φωτιά, πρέπει οι ασφάλειες να αντικαθιστούνται με ίδιου τύπου. Η χρήση άλλων ασφαλειών ή αντικειμένων απαγορεύεται.



Το τροφοδοτικό στο εσωτερικό του μηχανήματος θα παραμείνει ζεστό και υπάρχουν περιοχές με υψηλή τάση παρ'όλο που το μηχάνημα δεν δουλεύει, και υπάρχει η πιθανότητα ηλεκτρικού σοκ. Προσοχή να μην ακουμπήσεις αυτές τις περιοχές.



Για την αποφυγή ηλεκτρικών σοκ λόγω βλάβης, το μηχάνημα ΠΡΕΠΕΙ να έχει πρώτα ενωθεί με γείωση.



Εάν κάποια στιγμή καταστραφεί η κύρια παροχή, πρέπει να αντικατασταθεί αμέσως.



Να μην ανάψει το μηχάνημα (switch ON) μέχρι να έχει εγκατασταθεί σωστά και πλήρως.



Πριν την παροχή ρεύματος στο μηχάνημα, να είσαι σίγουρος ότι τα voltage και όλες οι ασφάλειες είναι σωστά ενωμένα και τοποθετημένα.

ΣΗΜΕΙΩΣΕΙΣ ΓΙΑ ΤΗΝ ΕΓΚΑΤΑΣΤΑΣΗ



ΠΟΤΕ να μην ανάβει το μηχάνημα εάν δεν έχει ολοκληρωθεί η εγκατάσταση.



Για την αποφυγή ηλεκτρικών σοκ πρέπει το μηχάνημα να έχει γειωθεί.



Για την αποφυγή βλάβης στο μηχάνημα λόγω λάθος λειτουργίας , πρέπει η παροχή να είναι 230volt AC..

ΣΗΜΕΙΩΣΗ: Εάν το πάτωμα στο οποίο είναι τοποθετημένο το μηχάνημα γλιστράει, είναι καλό να μπει ένα κομμάτι μοκέτας για αποφυγή μετακίνησης του μηχανήματος εν ώρα λειτουργίας του.

ΣΗΜΕΙΩΣΗ: Για την εύκολη πρόσβαση στην κυρίως παροχή ή το CPU πρέπει η πίσω πόρτα του μηχανήματος να απέχει τουλάχιστον 500mm από τον τοίχο ή άλλο μηχάνημα.

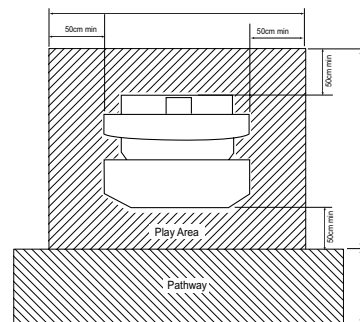

Το μηχάνημα είναι εφοδιασμένο με καρούλια για την εύκολη μετακίνησή του.



Το συνολικό ύψος της κεφαλής είναι 1940mm . Φρόντισε να μην χτυπήσει σε λάμπες κ.λ.π.

ΑΠΟΜΑΚΡΥΝΣΗ ΚΑΙ ΑΝΤΙΚΑΤΑΣΤΑΣΗ ΜΕΡΩΝ - ΑΝΤΑΛΛΑΚΤΙΚΩΝ



Εγκατάσταση , μετατροπή ή έλεγχος ρουτίνας μπορεί να γίνεται μόνο από εξουσιοδοτημένα άτομα .



Δεν πρέπει να γίνονται μετατροπές στα μηχανήματα χωρίς έγκριση . Μπορεί να προκληθεί απρόβλεπτος κίνδυνος.



Μόνο μέρη που διευκρινίζονται από την εταιρεία NAMCO EUROPE Ltd μπορούν να χρησιμοποιηθούν για αντικατάσταση ή επιδιόρθωση. (συμπεριλαμβάνονται και οι βίδες)



Να είναι σίγουρα κλειστό το ρεύμα πριν οποιαδήποτε δουλειά στο μηχάνημα.



Εάν γίνει κάποια δουλειά στο μηχάνημα χωρίς να διευκρινίζεται στο εγχειρίδιο , να επικοινωνήσεις με τον αντιπρόσωπο για οδηγίες γιατί καμία ευθύνη δεν φέρουμε για καταστροφές ή βλάβες.



Μέρη του τροφοδοτικού ή του μόνιτορ παραμένουν ζεστά ή έχουν υψηλή τάση ακόμα και όταν σβήσει το μηχάνημα και μπορούν να προκαλέσουν κάψιμο ή λεκτροσόκ. Γιαυτό δεν πρέπει να έρχονται σε επαφή με χέρια .



Το μηχάνημα πρέπει να είναι σβηστό κατά την σύνδεση ή αποσύνδεση πρίζας ή κονέκτορα.



Κατά την απομάκρυνση των κεντρικών κονέκτορ από το μηχάνημα ή της κυρίας πρίζας , πρέπει να πιάνουμε το πλαστικό μέρος και όχι το καλώδιο.



Nessuna parte di questa pubblicazione può essere riprodotta con processo meccanico, fotografico o elettronico, nè sotto forma di registrazione fonografica, nè può essere memorizzata in un sistema di salvataggio, trasmessa o in altro modo copiata per uso pubblico o privato, senza l'autorizzazione di **NAMCO EUROPE LIMITED**.

Le informazioni contenute in questo manuale sono state date in buona fede ed erano accurate al momento della pubblicazione. Tuttavia NAMCO EUROPE LIMITED, si riserva il diritto di apportare cambiamenti e variazioni senza alcun preavviso.

Questo apparecchio è stato costruito in conformità alle Direttive della Comunità Europea, ed è stato provato e soddisfa le Direttive 89/336/EEC e 72/23/EEC per l'applicazione degli standards delle norme EN55014-1, EN55014-2 e EN60335-2-82 (vedi fronte del manuale), e per questo porta il marchio CE. Qualsiasi cambiamento o modifica di questo apparecchio deve essere in conformità con le Direttive della Comunità Europea.

In caso di condizioni di estrema interferenza dall'esterno, per esempio trasmissioni radio, scariche elettrostatiche o transistori sulla linea, può verificarsi un decadimento delle prestazioni. Comunque l'apparecchio ritornerà al rendimento normale quando la sorgente dell'interferenza avrà cessato di emettere o sarà stata rimossa.

Nota bene: se il processore del gioco "resetta" a causa di una interruzione o diminuzione del voltaggio di linea, un eventuale credito, già concesso, può essere annullato.

Questo gioco non è una macchina così come viene definita dalla Direttiva Macchine 89/392/EEC.

AVVERTENZE PER LA SICUREZZA

Allo scopo di usare questo apparecchio in sicurezza, leggere questo Manuale dell'operatore attentamente prima dell'installazione, regolazione o uso di questa macchina.

Tutte le volte che il proprietario di questo apparecchio affida lo smontaggio, l'installazione, la regolazione o la manutenzione ordinaria ad un'altra persona, il proprietario stesso deve assicurarsi che quella persona legga le precauzioni necessarie e i paragrafi importanti di questo manuale prima di iniziare a lavorare.

Perchè non succeda alcun incidente quando la macchina è operante, seguire rigorosamente le note sulla sicurezza come specificato più avanti.

Questo manuale insieme con il manuale di installazione (dove si può applicare) forma una parte integrante dell'apparecchio e deve essere disponibile sempre al personale operante e di servizio.

Questa macchina deve essere usata solo in interni e deve essere usata solo per gli scopi per cui è progettata.

Namco Europe Ltd non si assume responsabilità per incidenti, ferite o danni risultanti da cambiamenti non autorizzati o da uso improprio della macchina.

NOTE PER LA SICUREZZA

Le seguenti note sulla sicurezza sono usate dal principio alla fine di questo manuale. Valutare attentamente ciascuna di queste note ed il loro significato prima di installare, fare assistenza o regolazioni su questa macchina.

WARNING  "Warning" evidenzia un rischio di ferita o di morte. Non procedere oltre una nota "Warning" finchè le avvertenze specificate non siano completamente capite e conosciute.

CAUTION  "Caution" evidenzia un rischio di danneggiare la macchina. Non procedere oltre una nota "Caution" finchè le avvertenze specificate non siano completamente capite e conosciute.

CONSIDERAZIONI GENERALI SULLA SICUREZZA



Mettere in funzione l'apparecchio solo dopo aver controllato che l'installazione sia stata effettuata correttamente ed in conformità alle istruzioni del manuale.



Gli avvisi "Warning" devono sempre essere conservati in buone condizioni e sostituiti se consumati, cosicché il cliente li possa leggere chiaramente.



L'installazione, l'assistenza, le regolazioni e la manutenzione ordinaria devono essere eseguite solo da persone idonee e qualificate.



Per una protezione costante contro il rischio di fuoco, assicurarsi che i fusibili sulle alimentazioni siano solo sostituiti con lo stesso tipo e caratteristiche. L'uso di altri fusibili o materiali è proibito.



L'alimentatore all'interno del monitor rimane caldo ed ha zone di alto voltaggio anche se la macchina è stata spenta, c'è quindi la possibilità di bruciature o scosse elettriche. Fare attenzione a non toccare queste zone.



Per prevenire possibili scosse elettriche dovute a difetti, questa macchina DEVE essere installata con un connettore sicuramente MESSO A TERRA.



In caso il cavo di alimentazione di rete risultasse danneggiato deve essere sostituito immediatamente.



Non accendere la macchina finchè la stessa non è stata installata completamente e correttamente.



Prima di collegare la macchina alla rete, assicurarsi che la macchina sia preparata per il voltaggio corretto e che siano inseriti i fusibili adatti.

NOTES D'INSTALLATION



NON ACCENDERE MAI la macchina finchè l'installazione non è stata completata.



Allo scopo di prevenire possibili scosse elettriche, la macchina deve essere obbligatoriamente collegata alla rete con un connettore messo a terra con connessioni sicure.



Per evitare danni alla macchina durante la messa in opera, assicurarsi che il voltaggio della rete sia 230 volts AC.

Note: Il luogo di destinazione della macchina deve avere il pavimento liscio e si raccomanda di sistemare dei cuscinetti di gomma sotto i piedini di livellamento per prevenire lo scivolamento della macchina sul pavimento.

Note: Per garantire l'accesso all'alimentatore e alla scheda madre, assicurarsi che il retro del mobile principale sia separato dalla parete o da altre macchine di almeno 500mm.

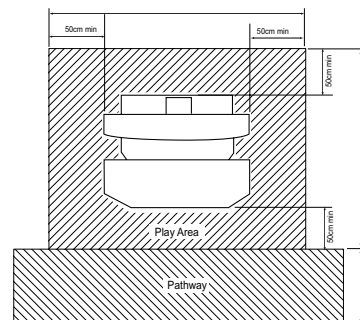

Il gioco è fornito di ruote per rendere più facile il suo spostamento. Fare attenzione quando si muove la macchina su una superficie inclinata.



L'altezza totale della parte principale è 1940mm, fare attenzione ad eventuali ostacoli sopra la testata ovvero ad eventuali installazioni di luci.

RIMOZIONE E SOSTITUZIONE DI GRUPPI E PARTI STACCATE



L'installazione, l'assistenza, le regolazioni e la manutenzione ordinaria devono essere eseguite solo da persone idonee e qualificate.



Non apporre alcuna modifica alla macchina senza autorizzazione preventiva. Il fare questo può causare un pericolo non prevedibile.



Quando si rimpiazza o si riparano delle parti (incluse le viti) si possono usare solo parti approvate dalla Namco Europe Ltd.



Assicurarsi che la macchina sia SPENTA prima di incominciare qualsiasi lavoro di manutenzione (guasti, riparazioni etc.)



Se state per iniziare un lavoro non descritto in questo manuale, contattate il vostro distributore per istruzioni poichè non si accetta alcuna responsabilità per danni o ferite.



Parti dell'alimentatore e del monitor rimangono caldi o portano alta tensione anche dopo aver spento l'apparecchiatura e possono causare bruciature o scosse elettriche. Attenzione a non toccare queste parti accidentalmente.



Assicurarsi che la macchina abbia l'interruttore nella posizione OFF prima di inserire o disinserire qualsiasi connettore o spina.



Quando vengono rimossi i connettori principali dalla macchina oppure la spina dell'alimentazione dalla parete bisogna sempre afferrare il connettore e non il cavo.



Ingen del av denne utgivelsen må reproduseres av noen mekaniske, fotografiske eller elektroniske prosesser, eller i form av fotografiske opptak, og ikke kan det lagres i et gjenvinnbart system, sendt eller kopiert for offentlig eller privat bruk, uten tillatelse fra NAMCO EUROPE LIMITED.

Da informasjonen i denne manualen er gitt i god tru og var korrekt da den ble utgitt, tillegger NAMCO EUROP LIMITED seg retten til å lage forandringer uten varsel.

Denne maskinen er produsert i samsvar med direktiver framsatt av det Europeiske samfunn. Maskinen er testet og samsvarer med direktivene 89/336/EEC og 72/23/eec med anvendelse av EN55014-1, EN55014-2 og EN60335-2-82 standarder (se i begynnelsen av manualen), og derfor bærer CE merket. Hvilken som helst forandring eller modifisering må skje etter direktivene satt av det Europeiske samfunn. Uautoriserte forandringer på dette produktet, kan motstride disse direktivene.

Under noen forhold av ekstreme ytre forstyrrelser, f.eks radio sendere, elektronisk utladning eller transiente spenninger, kan man regne med noe senket ytelse. Men maskinen vil oppnå normal ytelse når kilden til forstyrrelsene opphører eller er fysisk fjernet.

Merk:- Hvis spilllets prosessor resettes p.g.a et kutt eller reduksjon av hovedspenningen kan oppsparte kreditt på spillet forsvinne.

Dette spillet er ikke en maskin som er definert ved Maskin direktivet 89/392/EEC.

Sikkerhets advarsel.

For å bruke denne maskinen uten noe form for fare, sørg for å lese denne manualen nøye før installasjon, justeringer eller bruk av maskinen.

Når eieren av denne maskinen overlater avmontering, installasjon, justering eller rutine vedlikehold til en annen person, skal eieren forsikre seg om at denne personen leser de passende forsiktighetsreglene og relevante deler av manualen før han starter på arbeidet.

For å forhindre at ulykker inntreffer når maskinen er i drift, følg strengt teksten om sikkerhet som beskrevet nedenfor.

Denne manualen sammen med installasjons manualen (hvor det er anvendelig) er en intrigert del av utstyret og må være tilgjengelig for drift- og servispersonell til alle tider.

Denne maskinen er bare for innendørs bruk og skal bare benyttes etter mente hensikter.

Namco Ltd. bærer intet ansvar ved ulykker, kvestelse eller skade som følge av uautoriserte forandringer, eller for uriktig bruk av maskinen.









Sikkerhets beskjeder.

Følgende sikkerhets punkter er brukt ut denne manualen. Gjør deg kjent med disse punktene og deres mening før installasjon, service eller du utfører noen innstillinger på denne maskinen.

ADVARSEL  Advarsel innebærer en risiko som kan føre til kvestelse eller død. Ikke fortsett utover advarslen før den er ordentlig forstått og mottiltak er igangsatt.

FORSIKTIG  Forsiktig innebærer en risiko som kan medføre skade på maskinen. Ikke fortsett utover advarslen før den er ordentlig forstått og mottiltak er igangsatt.

VANLIGE SIKKERHETSTILTAK

-  **Bruk bare denne maskinen etter å ha kontrollert at den er korrekt installert ifølge manualen.**
-  **Advarsel skiltene må bestandig holdes i skikket stand og eventuelt byttes ut hvis det oppstår skade på dem, slik at kunden uten vanskelighet kan lese dem.**
-  **Installasjon, service, justering eller rutine vedlikehold skal bare utføres av kvalifiserte personer.**
-  **For fortsatt beskyttelse mot brann, forsikre deg at hoved sikringen bare byttes ut med en av samme type og verdi. Bruk av andre sikringer eller materiale er forbudt.**
-  **Strømforsyningen inne i monitoren vill være varm og ha områder med høy spenning selv om maskinen har blitt slått av. og det er muligheter for skader og elektriske sjokk. Vær forsiktig så du ikke berører disse områdene.**
-  **For å forhindre mulige elektriske sjokk grunnet funksjonsfeil, må denne maskinen være ordentlig jordet.**
-  **Hvis ledningen til hoved strømforsyningen skades må den straks byttes ut.**
-  **Ikke slå på maskinen før den er korrekt installert.**
-  **Før du kopler maskinen til strømmettet, forsikre deg om at maskinen innstilt for den korrekte spenningen og de riktige sikringene benyttes.**

MERKNADER VED INSTALLASJON



Slå ALDRI på maskinens strømforsyning før installasjonen er fullført.



For å forhindre eventuelle elektriske sjokk, forsikre deg om at maskinen er koplet til et strømnnett med ordentlig jording.



For å forhindre skade på maskinen p.g.a. feil bruk, sørg for at spenningen til hoved strømforsyningen er 230Volt AC.

MERKNADER: Hvis plassen hvor spillet skal plasseres har polerte gulv anbefales det at du benytter gummi sko under nivå justeringene, for å forhindre at maskinen kan flytte på seg.

MERKNADER: For å få adgang til strømforsyningen og CPU-kort, forsikre deg om at bakparten av hoved kabinettet er skilt fra vegger eller andre maskiner med minst 500mm.

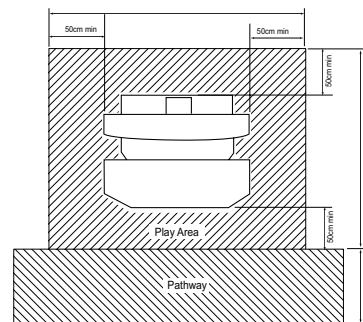

Spillet har montert hjul for å gjøre det letter å flytte på. Hver forsiktig når det skal flyttes på en hellende overflate.



Den totale høyden på hoved enheten er 1940mm. vær forsiktig med høye hindringer som f.eks lysrør.

FJERNE OG UTSKIFTE ENHETER OG DELER.



Installasjon, service, justering eller rutine vedlikehold skal bare utføres av kvalifiserte personer.



Ikke lag noen forandringer på denne maskinen uten godkjenning. Dette kan medføre uforutsette farer.



Bare deler spesifisert av Namco Europe Ltd. skal benyttes ved utskifting eller reparasjon av deler (dette gjelder også skruer).



Forsikre deg om at strømmen er slått av før du påbegynner noe som helst vedlikeholdsarbeid (feilsøking, reparasjon osv.)



Hvis du utfører arbeid som ikke er beskrevet i denne manualen, ta kontakt med din distributør for instruksjon da ikke noe ansvar vill bli akseptert for skade på maskin eller på personer.



Deler av strømforsyningen og monitoren er fortsatt varm eller bærer høye spenninger selv etter strømmen er slått av og kan forsaake skader eller elektriske sjokk. Forsikre deg om at du ikke berører disse delene.



Forsikre deg om at maskinen er slått av før du kopler sammen eller tar fra hverandre pluggen eller kopligner.



Når du fjerner hoved koplignene fra maskinen, eller hoved pluggen fra støpselet, ta bestandig tak i pluggen og ikke ledningen.



Niets uit deze publikatie mag worden gereproduceerd door enig mechanisch, fotografisch of elektronisch proces, of in de vorm van een fonografische opname, noch mag het opgeslagen worden in een retrieval systeem, doorgezonden of anderszins gekopieerd voor publiek of privégebruik, zonder toestemming van Namco Europe Limited.

Ofschoon de informatie in deze handleiding in goed vertrouwen is gegeven en nauwkeurig was ten tijde van het drukken, houdt Namco zich het recht voor om veranderingen en aanpassingen te maken zonder bericht.

Deze machine is geproduceerd volgens Richtlijnen van de Europese Gemeenschap, en is getest en is in overeenstemming met de Richtlijnen 89/336/EEC en 72/23/EEC door de toepassing van de standaards EN55014-1, EN55014-2 en EN60335-2-82 (zie voorin de handleiding) en draagt als zodanig het CE-merk. Enige veranderingen of aanpassingen aan deze machine dienen in overeenstemming te zijn met de Richtlijnen van de Europese Gemeenschap. Enige ongeauthoriseerde veranderingen aan dit produkt kunnen in strijd zijn met deze Richtlijnen.

Onder sommige omstandigheden van extreme externe storingen, bijv. radiotransmissies, electrostatische ontladingen of pieken op het net, kan prestatieruggang optreden. De machine zal echter normaal presteren zodra de storingsbron gestopt of verwijderd is.

Let op: - als de spelprocessor reset a.g.v. een onderbreking of vermindering van de netstroom, dan kunnen opgebouwde credits verloren gaan.



Dit spel is niet een machine zoals omschreven in de Machinery Directive 89/392/EEC.

Veiligheidsopmerkingen









Om deze machine veilig te kunnen gebruiken, dient vóór installatie, aanpassing of gebruik van deze machine, de Bedieningshandleiding zorgvuldig gelezen te worden. Telkens wanneer de eigenaar van deze machine de demontage, installatie, aanpassing of routine-onderhoud toevertrouwd aan een andere persoon, dient de eigenaar er voor te zorgen dat deze persoon de juiste voorzorgsmaatregelen en relevante gedeeltes uit de handleiding leest voordat hij begint. Om er voor te zorgen dat geen ongelukken gebeuren als de machine gebruikt wordt, dienen onderstaande veiligheidsaanwijzingen zorgvuldig opgevolgd te worden. Deze handleiding maakt samen met de installatiehandleiding (waar van toepassing) een integraal deel uit van de apparatuur en moet te allen tijde ter beschikking staan van exploitatie- en onderhoudspersoneel. Deze machine is alleen bedoeld voor gebruik binnenshuis en dient alleen gebruikt te worden voor bedoelde doeleinden. Namco Ltd. is niet verantwoordelijk voor ongelukken, letsel of schade die voortkomt uit ongeoorloofde veranderingen aan of onjuist gebruik van deze machine.

Veiligheidsopmerkingen

De volgende veiligheidsopmerkingen worden overal in deze handleiding gebruikt. Maak uzelf vertrouwd met deze opmerkingen en hun betekenis vóór installatie, het plegen van onderhoud of het aanbrengen van aanpassingen aan deze machine.

- WAARSCHUWING**  **Waarschuwing geeft een gevaar aan dat zou kunnen resulteren in letsel of de dood. Ga niet verder dan een waarschuwingsofmerking totdat de aangegeven omstandigheden volledig begrepen zijn en hieraan voldaan is.**
- VOORZICHTIG**  Voorzichtig geeft een gevaar aan dat zou kunnen resulteren in schade aan de machine. Ga niet verder dan een voorzichtigheidsopmerking totdat de aangegeven omstandigheden volledig begrepen zijn en hieraan voldaan is

ALGEMENE VEILIGHEIDSOVERWEGINGEN

-  **Stel deze machine alleen in gebruik nadat gecontroleerd is of de machine correct en overeenkomstig de handleiding is geïnstalleerd.**
-  **De waarschuwingstickers dienen altijd in goede staat te worden gehouden en vervangen indien versleten, zodat de klant ze goed kan lezen.**
-  **Installatie, service, aanpassingen of routine-onderhoud dient alleen uitgevoerd te worden door hierin bewaarde personen.**
-  **Om blijvende bescherming tegen brandgevaar te garanderen, dient ervoor gezorgd te worden dat de netzekeringen alleen vervangen worden door zekeringen van hetzelfde type en dezelfde sterkte. Het gebruik van andere zekeringen of ander materiaal is verboden.**
-  **De voeding in de monitor blijft warm en er kunnen componenten electrisch geladen blijven ondanks dat de machine UITgeschakeld is, waardoor er brandwonden of electrische schokken kunnen worden opgelopen. Ben voorzichtig en raak deze delen niet aan.**
-  **Om mogelijke electrische schokken a.g.v. storingen te voorkomen, MOET deze machine voorzien zijn van een goed vastzittende aardstekker.**
-  **Mocht het netsnoer op enig moment beschadigd worden, dan moet deze onmiddellijk vervangen worden.**
-  **Zet de machine niet AAN totdat deze correct is geïnstalleerd.**
-  **Voordat de machine op het lichtnet wordt aangesloten, dient gecontroleerd te worden of de machine op het correcte voltage staat afgesteld en of de correcte zekeringen zijn aangebracht.**

Opmerkingen aangaande Installatie



Sluit de machine nooit aan op de stroomtoevoer totdat de installatie is voltooid.



Om mogelijke elektrische schokken te voorkomen, dient ervoor gezorgd te worden dat de machine middels een goed vastzittende aardstekker op het lichtnet is aangesloten.



Om schade aan de machine door verkeerd gebruik te voorkomen, dient ervoor gezorgd te worden dat het voltage van het lichtnet 230volts AC bedraagt.

OPMERKING: Als de machine op een gladde ondergrond wordt gebruikt, is het raadzaam rubber matjes onder de stelvoetjes te bevestigen om te voorkomen dat de machine over de vloer gaat glijden.

OPMERKING: Om toegang te krijgen tot de voeding- en de CPU-assemblies, dient ervoor gezorgd te worden dat de achterkant van het kabinet minimaal 500mm verwijderd is van de muur of andere machines.

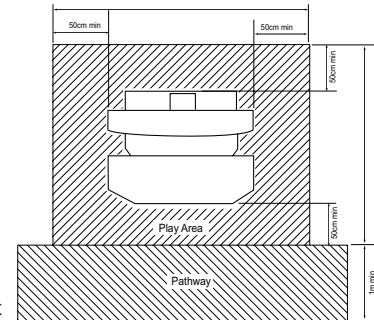

Het spel is voorzien van wieltjes, waardoor het gemakkelijker is om te verplaatsen. Wees voorzichtig als de machine op een hellend vlak gereden wordt.



De hoogte van het hoofdgedeelte is 1940mm: kijk dus uit voor obstakels zoals lampen.

Verwijderen en vervangen van Assemblies en onderdelen



Installatie, service, aanpassingen of routine-onderhoud dient alleen uitgevoerd te worden door hierin bekwame personen.



Maak geen veranderingen aan deze machine zonder goedkeuring vooraf. Dit kan onvoorzien gevaar opleveren.



Alleen onderdelen die door Namco Europe Ltd. zijn gespecificeerd dienen gebruikt te worden bij het vervangen of repareren van onderdelen (incl. schroeven).



Zorg ervoor dat de machine UITgeschakeld is voordat er enig onderhoudswerk wordt verricht (troubleshooting, reparaties etc.)



Bij het verrichten van werkzaamheden die niet in deze handleiding staan beschreven, dient voor instructies altijd contact opgenomen te worden met de verdeler aangezien geen verantwoording wordt genomen voor schade of letsel.



Delen van de voeding en de monitor blijven warm of behouden hoogspanning zelfs nadat de machine UITgeschakeld is en zouden verbrandingen of elektrische schokken kunnen veroorzaken. Ben voorzichtig en raak deze delen niet per ongeluk aan.



Zorg ervoor dat de machine is UITgeschakeld voordat pluggen of connectors ingestoken of uitgetrokken worden.



Als het netsnoer uit de machine of uit het stopcontact verwijderd wordt, dient altijd de stekker vastgepakt te worden en niet het snoer.



Nenhuma parte desta publicação poderá ser reproduzida por processos mecanográficos, fotográficos, electrónicos ou ainda sob a forma de gravação sonora nem tão pouco poderá ser gravada através de sistemas informáticos transmissíveis ou de outra forma copiados para uso publico ou privado sem autorização expressa da NAMCO EUROPA LIMITADA.

A informação contida neste manual foi fornecida de boa fé, sendo rigorosa na altura da sua publicação. A NAMCO EUROPA LIMITADA, reserva-se o direito de proceder a mudanças e alterações sem qualquer aviso prévio.

Esta maquina foi fabricada de acordo com as Directivas Comunitárias Europeias e tem sido testada em conformidade com as seguintes Directivas: 89/336/EEC e 72/23/EEC através dos requerimentos normativos, EN55014-1, EN55014-2 e EN60335-2-82 (ver capa frontal do manual) e como tal sustenta o certificado de marca de CE. Quaisquier alterações ou modificações efectuadas nesta maquina deverão ser em conformidade com as Directivas da Comunidade Europeia. Quaisquier alterações não autorizadas a este equipamento poderão infringir tais Directivas.

O funcionamento normal desta maquina, poderá ser afectado debaixo de algumas condições extremas de interferências externas tais como; transmissões via radio, descargas electroestáticas e passagens de corrente na rede de alimentação. Contudo o seu funcionamento normal será restabelecido logo que a fonte de interferências tenha cessado ou tenha sido neutralizada.

Nota :- Se o processador de jogo for inicializado devido a uma interrupção ou quebra da corrente principal, quaisquer credits obtidos poderão desaparecer.

Este jogo por si só não constitui uma maquina tal como defenido pelas Directivas de Maquinaria de 89/392/EEC8.

AVISOS DE SEGURANÇA

Afim de usar esta maquina com segurança, certifique-se que lê este manual de operador atentamente antes de proceder á montagem e afinação ou uso da mesma.

Sempre que o proprietário desta maquina confiar a desmontagem, instalação, afinação ou manutenção preventiva da mesma a outra pessoa, deverá este assegurar - se que a pessoa em questão lê as precauções apropriadas e capitulos relevantes deste manual antes de iniciar o trabalho.

Afim de evitar qualquer tipo de acidente quando a maquina estiver em funcionamento, deverá seguir rigorosamente os procedimentos de segurança descritos abaixo.

Este manual juntamente com o manual de instalação (aonde aplicavel), contiuem parte integrante do equipamento e deverão estar sempre disponiveis ao operador e pessoal técnico de assistência.

Esta maquina destina-se a ser operada em espaços interiores apenas e a sua utilização deve circunscrever-se somente aos fins previstos.

A Namco Ltd. declina qualquer responsabilidade por acidentes, ferimentos ou danos resultantes de modificações não autorizadas ou uso indevido desta maquina.









AVISOS DE SEGURANÇA

Os seguintes avisos de segurança são usados através de todo o manual. Familiarize-se com cada um destes avisos e respectivos significados antes de instalar, assistir ou efectuar qualquer afinação nesta maquina.

PERIGO  **Perigo revela uma situação anormal que poderá resultar em ferimentos ou morte. Não avance para além de um aviso de Perigo sem que todas as condições indicadas estejam completamente esclarecidas e resolvidas.**

CAUTELA  **Cautela revela uma situação anormal que poderá resultar em danos materiais para a maquina. Não avance para além de um aviso de Cautela sem que todas as condições indicadas estejam completamente esclarecidas e resolvidas.**

AVISOS DE PERIGO

-  **Esta maquina só deverá ser colocada em funcionamento após ter sido verificado que se encontra instalada correctamente e de acordo com o manual de instruções.**
-  **Os avisos de perigo devem ser sempre mantidos em boas condições de leitura de forma a permitir uma leitura clara por parte do utilizador, caso se encontrem danificados deverão ser substituídos.**
-  **A montagem, assistência e afinações ou manutenção de rotina desta maquina, deverão ser somente executadas por técnicos ou pessoas devidamente qualificadas para o efeito.**
-  **Afim de garantir uma proteção anti - fogo permanente nesta maquina, certifique-se que os fusíveis de proteção são sempre substituídos por fusíveis de igual valor ou calibre aos de origem. O uso de outro tipo de fusíveis ou material é proibido.**
-  **A fonte de alimentação do monitor encontrar-se-à quente, tendo zonas de alta voltagem, mesmo após a maquina ter sido desligada. Deste facto poderá resultar a ocorrência de queimaduras ou choques electricos. Seja cuidadoso para evitar contacto com estas zonas.**
-  **Esta maquina deve estar sempre equipada com uma ficha com circuito de protecção à Terra, afim de evitar possíveis choques electricos, caso surja uma falha no sistema.**
-  **Se a qualquer altura o cabo de alimentação principal ficar danificado, deverá ser imediatamente substituído.**
-  **Não ligar a maquina sem que esta tenha sido correctamente instalada.**
-  **Antes de ligar a maquina à tomada da rede de alimentação principal, certifique-se de que a maquina está preparada para a voltagem correspondente e de que também se encontra protegida com os fusíveis apropriados.**

NOTAS SOBRE A INSTALAÇÃO



NUNCA ligar a maquina sem que a instalação esteja completamente finalizada.



Afim de evitar possiveis choques electricos, certifique-se que a maquina está ligada à rede de alimentação com uma ficha protegida com circuito de terra.



Afim de evitar danos na maquina causados por falhas de operação, certifique-se que a voltagem da rede de alimentação principal é de 230volt AC.

NOTAS : Se esta maquina estiver colocada sobre um chão polido, recomenda-se a utilização de tapetes de borracha debaixo dos pés niveladores, afim de prevenir a maquina de deslizar no chão.

NOTAS : Quando precisar de aceder à fonte de alimentação e às placas (CPU), certifique-se que a parte trazeira do móvel central está separada da parede ou de outras maquinas pelo menos 500mm afim de ganhar espaço de manobra.

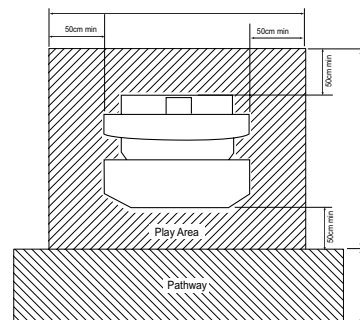

Esta maquina está equipada com rodas afim de facilitar a sua deslocação tenha cuidado ao mover a maquina num plano inclinado.



A altura total do bloco principal, é de 1940mm, tenha cuidado com qualquer tipo de obstruções existentes em altura como por exemplo; calhas electricas ou candeiros.

SUBSTITUIÇÃO E MONTAGEM DE PEÇAS



A montagem, assistência e afinações ou manutenção de rotina desta maquina, deverão ser somente executadas por tecnicos ou pessoas devidamente qualificadas para o efeito.



Não faça qualquer tipo de alteração prévia nesta maquina sem aprovação prévia. Se tal acontecer poderá provocar danos e perigos imprevisiveis.



A substituição ou reparação de peças deverá ser feita apenas com peças de origem ou especificadas pela "Namco Europa Ltd." (incluindo parafusos)



Certifique-se que a maquina se encontra desligada sempre que iniciar qualquer tipo de trabalho de manutenção. (identificação de avarias, reparação etc.)



Caso esteja a efectuar um trabalho não descrito neste manual, certifique-se que contacta o seu distribuidor para obter instruções, caso contrário não serão aceites responsabilidades por danos causados ou ferimentos.



Algumas zonas da fonte de alimentação e do monitor ficam quentes e transportam correntes de alta voltagem, mesmo depois de a maquina ter sido desligada, podendo causar queimaduras e choques electricos. Tome cuidado para não tocar acidentalmente estas zonas.



Certifique-se que a maquina está desligada antes de ligar ou desligar qualquer tipo de fichas ou junções.



Quando desligar a ficha principal da maquina ou a ficha do cabo de alimentação das tomadas da parede, deverá sempre agarrar na ficha e nunca puxar pelo cabo da mesma.



Ingen del av denna publikation får reproduceras, varken fotografiskt, elektroniskt eller i någon form av ljudinspelning. Det får inte heller lagras i något återvinningssystem, översändas eller på annat sätt kopieras för offentlig eller privat användning, utan tillstånd från NAMCO EUROPE LIMITED.

Eftersom informationen i denna manual lämnas ut i god tro och var korrekt när den trycktes, reserverar sig NAMCO EUROPE LIMITED för ändringar.

Denna maskin har tillverkats enligt direktiv från europeiska unionen, är testad och uppfyller direktiven enligt 89/336EEC och 72/23/EEC med tillämpning av EN55014-1, EN55014-2 och EN60335-2-82 standard (se manualens framsida) och bär därmed också CE-märket. Varje förändring eller modifiering av denna maskin måste ske i överensstämmelse med EU-direktiven. En förändring i denna produkt, som inte är auktoriserad, kan strida mot dessa direktiv.

Under vissa omständigheter när det gäller extrema externa störningar, t ex radiosändningar, elektrostatiska urladdningar eller nätburna strömstörningar, kan resultera i en något nedsatt funktion. Maskinen kommer dock att återgå till normal funktion, så snart störningen har upphört eller avlägsnats

SÄKERHETS VARNING

För att maskinen ska kunna användas på ett säkert sätt, ska manualen läsas noggrant före installation, användning eller justering.

Om ägaren till maskinen anförtror någon annan person att montera isär, installera, justera maskinen eller utföra rutinunderhåll, ska ägaren försäkra sig om att denna person läser om försiktighetsåtgärder och tillämpliga delar av denna manual innan arbetet påbörjas.

För att förhindra att någon olycka händer när maskinen är igång, måste säkerhetspunkterna beskrivna nedan följas strikt.

Denna manual tillsammans med installationsmanualen (när tillämpligt) utgör en integrerad del av utrustningen och måste vara ständigt tillgänglig för operatörer och service personal.

Maskinen är avsedd för inomhusbruk och ska endast användas för detta ändamål.

Namco Ltd. bär inget ansvar för olyckor eller skador som orsakats av icke auktoriserade ändringar i maskinen eller felaktigt användande av densamma.

SÄKERHETSANVISNINGAR

Säkerhetsanvisningarna nedan används genomgående i manualen. Gör dig förtrogen med varje anvisning och dess innebörd innan installation, service eller justeringar görs på denna maskin.

VARNING



"Varning" anger en fara som skulle kunna skada eller försäkra dödsfall. Fortsätt inte vid en sådan varningsanvisning innan de påvisade förhållandena är förstådda och åtgärdade i sin helhet.

OBSERVERA



"OBSERVERA" anger en fara som skulle kunna försäkra skada på maskinen. Fortsätt inte vid en sådan varningsanvisning innan de påvisade förhållandena är förstådda och åtgärdade i sin helhet.

ALLMÄNNA SÄKERHETSBEAKTANDEN



Sätt inte igång maskinen utan att ha kontrollerat att den är korrekt installerad och i överensstämmelse med manualen.



Varningsanvisningarna måste alltid hållas i gott skick och ersättas när de blir slitna, så att kunderna kan läsa dem tydligt.



Installation, service, justeringar eller rutinunderhåll ska endast utföras av en för ändamålet kvalificerad person.



För kontinuerligt skydd mot brandfara, ska man försäkra sig om att huvudsäkringarna endast ersätts med samma typ och specifikationer. Användandet av andra säkringar eller material är förbjuden.



Strömförsörjningen inne i monitorn håller sig varm och har områden med hög spänning, även när maskinen stängts av och det finns risk för brännskada eller elektriska stötar. Var försiktig och vidrör aldrig sådana områden.



För att förhindra en eventuell elektrisk stöt försäkra sig om att maskinen vara försedd med säkert ansluten JORDAD kontakt.



Om strömförsörjningskabeln på något sätt skadas, måste den bytas ut omedelbart.



Vrid inte strömbrytaren till ON innan maskinen är korrekt installerad.



Innan strömmen sätts på till maskinen, måste man försäkra sig om att den är inställd på rätt spänning och att rätt säkringar är isatta.

ATT BEAKTA VID INSTALLATION



Sätt aldrig på strömmen på maskinen innan installationen är klar.



För att förhindra elektriska chocker, försäkra dig om att maskinen kopplas till strömförsörjning med jordad kontakt



För att undvika skador på maskinen p g a felaktigt handhavande, försäkra dig om att strömstyrkan är 230 volt AC.

OBSERVERA: Om maskinen är placerad på ett polerat golv, rekommenderas att placera gummbrickor under nivåjusteringen för att förhindra att maskinen glider på golvet.

OBSERVERA: För att kunna komma åt strömförsörjningen och CPU, se till att baksidan av huvudkabinettet är placerat minst 500 mm från vägg eller annan maskin.

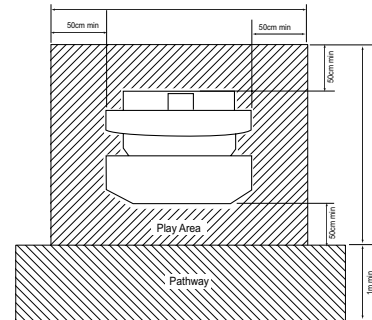

Spelet är försett med hjul för att underlätta förflyttningar. Var försiktig om spelet ska flyttas på en sluttande yta.



Den totala höjden är 1940 mm, tänk på eventuella högt placerade hinder, t ex lampor.

ATT TA BORT ELLER BYTA UT ENHETER OCH DELAR



Justeringar och underhåll på denna maskin skall endast utföras av kvalificerad personal.



Gör inga ändringar på denna maskin utan ett godkännande i förväg. Detta kan förorsaka oförutsägbar fara.



Endast delar som är specificerade av Namco Europe Ltd. ska användas vid utbyten eller reparation av delar (inklusive skruvar).



Försäkra dig om att strömmen är avstängd innan underhållsarbete påbörjas (felsökning, reparationer etc.)



Om arbete ska utföras som inte är beskrivet i denna manual, är det viktigt att kontakta återförsäljaren för instruktioner eftersom inget ansvar accepteras för åverkan eller personskador.



Delar av strömförsörjningen och monitorn är varma och strömbärande även efter strömmen stängts av och kan orsaka brännskador eller elektriska stötar.



Försäkra dig om att maskinen är avstängd innan kontakter sätts i eller tas ur.



När kontakten tas ur maskinen eller ur väggen, ta alltid tag i kontakten och inte i sladden.



Tästä julkaisusta ei saa ottaa missään muodossa kopioita yksityis- tai julkiseen käyttöön ilman **NAMCO EUROPE LIMITED**:in lupaa.

Tässä ohjekirjassa olevat tiedot pitävät julkaisuhetkellä paikkansa. NAMCO EUROPE LIMITED:illä on kuitenkin oikeus muutoksiin ilman erillistä ilmoitusta.

Tämä laite on valmistettu EC direktiivien mukaisesti. Se on testattu ja todettu noudattavan seuraavia direktiivejä: 89/336/EEC ja 72/23/EEC (EN55014-1, EN55014-2 ja EN 60335-2-82 standardit). Näin ollen tämä laite on varustettu CE-merkinnällä. Kaikki tähän laitteeseen kohdistetut muutokset on tehtävä EC- direktiivien mukaisesti. Mikä tahansa valtuuttamattoman huoltomiehen tekemä muutos voi olla direktiivien vastainen.

Laitteen toiminta voi häiriintyä määrättyissä olosuhteissa, jotka johtuvat äärimmäisistä ulkoisista sähköhäiriöistä, kuten radiolähetys, elektrostaattinen purkaus tai vahvavirrasta syntynyt häiriö. Toiminta normalisoituu kuitenkin heti, kun ulkoinen sähköhäiriö on poistettu.

Turvallisuusvaroitukset

Tämän laitteen turvallinen käyttö edellyttää käyttöohjekirjan huolellista lukemista ennen laitteen asennusta, säätöä tai käyttöä. Jos tämän laitteen omistaja antaa jollekin toiselle osapuolelle tehtäväksi purkaa, asentaa, säätää tai muuten huoltaa laitetta, on omistajan varmistuttava siitä, että toinen osapuoli on lukenut ja ymmärtänyt käyttöohjekirjan oleelliset osat ennen työhön ryhtymistä.

Turvallisuusohjeita on seurattava tarkoin vahinkojen välttämiseksi laitteen ollessa käytössä .

Tämä ohje sekä mahdollinen asennusohje muodostavat laitteiston oleellisen osan ja on siksi aina oltava huolto- ja käyttöhenkilökunnan käytettävissä.

Tämä laite on tarkoitettu vain sisätiläkäyttöön. Sitä ei saa käyttää muihin tarkoituksiin.

Namco Ltd ei vastaa niistä onnettomuuksista, loukaantumisista tai vahingoista, jotka johtuvat laitteeseen ilman Namco Ltd:n lupaa tehdyistä muutoksista laitteen väärästä käytöstä.

Turvallisuusohjeet

Tässä käyttöohjekirjassa on käytetty seuraavia turvallisuuden liittyviä huomautuksia. Tutustu jokaiseen näistä. Älä asenna, huolla tai säädä laitteistoa, ennen kuin olet täysin ymmärtänyt mitä ne tarkoittavat.

VAARA  "Vaara" tarkoittaa uhkaa, joka voi johtaa loukkantumiseen tai kuolemaan, **Älä koskaan ohita Vaara-merkintää, ennen kuin ohjeissa esitetyt olosuhteet on ymmärretty täysin.**

VAROITUS  "Varoitus" tarkoittaa uhkaa, joka voi johtaa laitteen vioittumiseen. Älä koskaan ohita Vaara-merkintää, ennen kuin ohjeissa esitetyt olosuhteet on ymmärretty täysin.

YLEISET TURVALLISUUNÄKÖKODAT



Varmista, että laite on asennettu oikein ja ohjekirjan mukaisesti ennen käyttöönottoa.



Varoituslaulut on pidettävä hyvässä kunnossa. Jos ne ovat kuluneet, ne on ehdottomasti vaihdettava, jotta asiakkaalla olisi mahdollisuus lukea niitä selvästi.



Vain riittävän ammattipätevyden omaava henkilö saa suorittaa asennus-, huolto-, säätö- tai muita laitteeseen kohdistuvia rutiinitoimenpiteitä.



Jotta palovaaraa ei syntyisi, saa pääsulakkeita vaihtaa vain samankokoisiin sulakkeisiin. Muiden sulakkeiden tai materiaalin käyttö on ehdottomasti kielletty.



Monitorin sisällä oleva virtalähde pysyy kuumana ja siinä on alueita, joissa on korkeaajännite vaikka laite on kytketty pois päältä. Palovammojen tai sähköiskun saaminen on mahdollista. Älä koske näihin alueisiin.



Sähköiskujen välttämiseksi vikatapauksissa, laite on ehdottomasti kytkettävä maadoitetulla johdolla maadoitettuun pistorasiaan.



Vioittunut verkkojohto on välittömästi vaihdettava.



Älä kytke laitetta päälle, ennen kuin se on oikein asennettu.



Varmista ennen verkkoon kytkemistä, että virtalähteen jännitteen asetus on asetettu oikealle jännitteelle ja että siinä on oikeat sulakkeet.

ASENNUSHUOMIOITA



Älä koskaan kytke laitetta päälle ennen kuin asennus on suoritettu loppuun.



Tämän laitteen virtalähde on kytkettävä maadoitetulla johdolla maadoitettuun pistorasiaan, jotta sähköiskun vaaraa ei olisi.



Varmista, että virtalähteen jännite on 230 V AC, jotta ei laite vioitu.

Huomio: Jos tämä laite sijoitetaan liukkaalle esim. vahatulle lattialle, suositellaan laitettavaksi kumityynyt säätöjalkoihin liikkumisen estämiseksi.

Huomio: Varmista, että takaosan taakse jää vähintään 500 mm tilaa, jotta virtalähteeseen ja CPU-korttiin pääsee käsiksi.

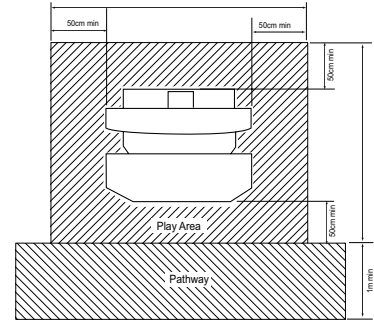

Laitte on varustettu kääntyvillä pyörillä. Tämä on pidettävä mielessä, kun laitetta siirretään kaltevalla alustalla.



Laitteen kokonaiskorkeus on yli 1940 mm. Varmista, ettei katossa ole esteitä. esim. valaisimia.



Vain riittävän ammattipätevyden omaava henkilö saa suorittaa asennus-, huolto-, säätö- tai muita laitteeseen kohdistuvia rutiinitoimenpiteitä.



Tälle laitteelle ei saa tehdä mitään hyväksymättömiä muutoksia. Se voi aiheuttaa ennalta-arvaamattomia vaaroja.



Vain Namco Europe Ltd:n määrittelemiä varaosia saa käyttää vaihtaessasi tai korjatessasi osia. (sisältäen ruuvit).



Varmista, että laite on kytketty POIS PÄÄLTÄ ennen työn aloittamista.



Ota yhteyttä maahantuojaan ohjeita varten, jos joudut tekemään työtehtäviä, joita ei ole esitelty huoltokirjassa, muuten vastuuta vioista tai loukkaantumisista ei ole.



Virtalähde ja monitori pysyvät kuumina ja niissä on alueita, joissa on korkeajännite vaikka laite on kytketty pois päältä. Palovammojen tai sähköiskun saaminen on mahdollista. Älä koske näihin laitteisiin.



Varmista, että laite on kytketty POIS PÄÄLTÄ ennen johtojen kytkemistä tai irrottamista.



Irrottaessasi verkkojohdon seinästä tai laitteesta, ota kiinni itse pistokkeesta, ei johdosta.

1. SPECIFICATIONS

INPUT VOLTAGE:-	230Volts AC / 250watts
AMBIENT OPERATING TEMPERATURE	+5°C to +35°C
MONITOR:-	Hantarex Polo 33" - 31kHz
COIN ACCEPTOR:-	
Game	Mars CashFlow 340 - Single Channel
Card Read/Write	Mars CashFlow 330
CARD READ/WRITER:-	Asahi Seiko CD-200 - 230mm
DIMENSIONS:-	
Assembled	1180(w) x 1500(d) x 2330(h)
Monitor Cabinet	1180(w) x 810(d) x 1940(h)
Control Cabinet	435(w) x 410(d) x 870(h)
Play Panel	1005(w) x 380(d) x 140(h)
Joint Bracket	785(w) x 317(d) x 180(h)
Header Assy	1145(w) x 390(d) x 5(h)
WEIGHT:-	
Assembled	201.5kg
Monitor Cabinet	155.5kg
Control Cabinet	16kg
Play Panel	20.5kg
Joint Bracket	5kg
Header Assy	.5kg
ACCESSORIES:-	Keys:
	(Cash Door) 2
	(Coin Door) 2
	(Read/Writer) 2
	(Rear Door) 2
	Tekken ID Cards 50
	IEC Mains Lead 1
	Operators Manual 1
	Monitor Manual 1
	CashFlow Documents 1

2. MAIN COMPONENTS

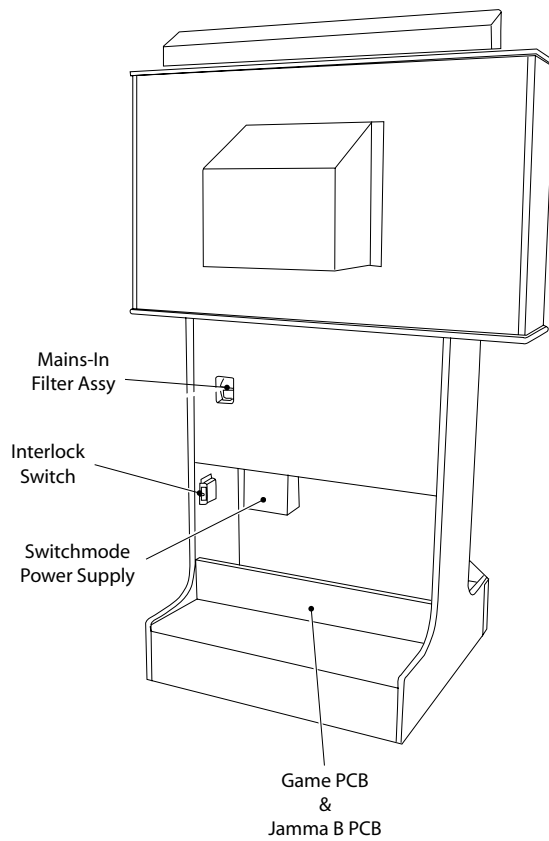
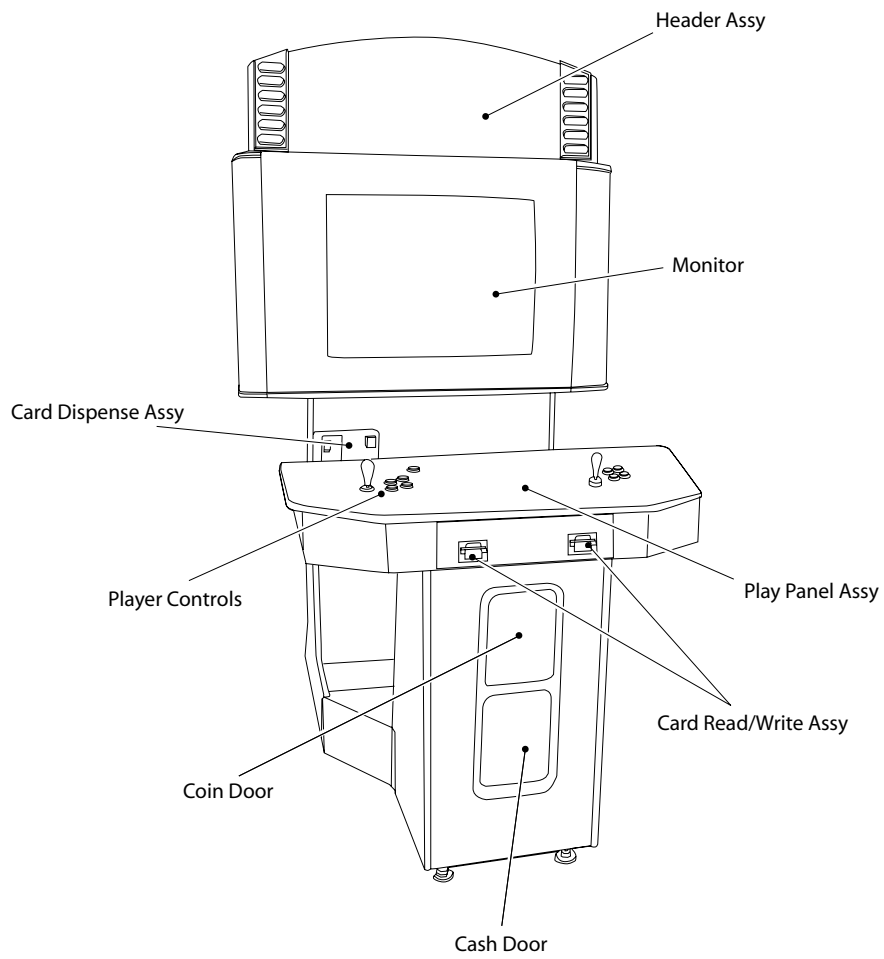

3. INSTALLATION

3-1 Joining the Play Panel and Monitor Cabinets

1. Fit the Joint Bracket to the Monitor Cabinet with 7 off Security screws.

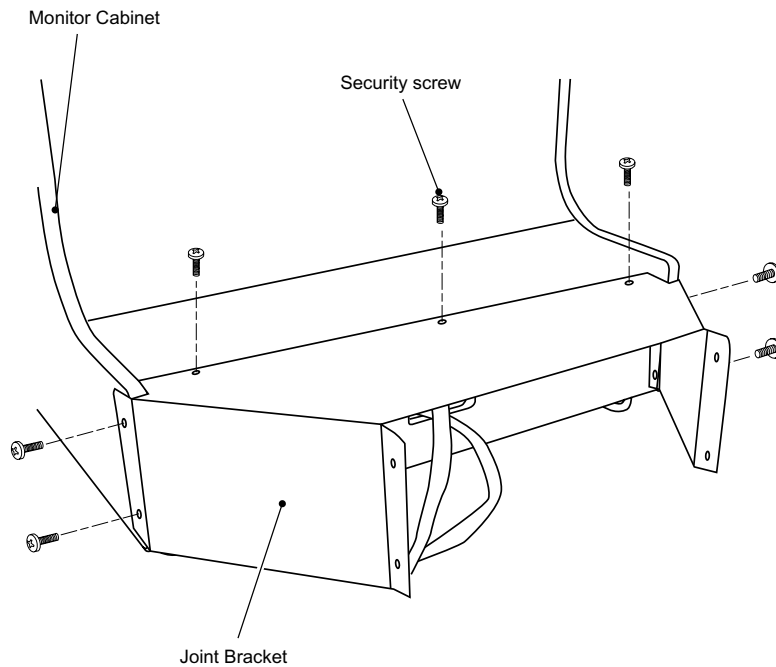

2. Connect the connectors.
3. Place the Play Panel Cabinet in position with the Joint Bracket, taking care not to trap any wires, and secure with 4 off security screws.

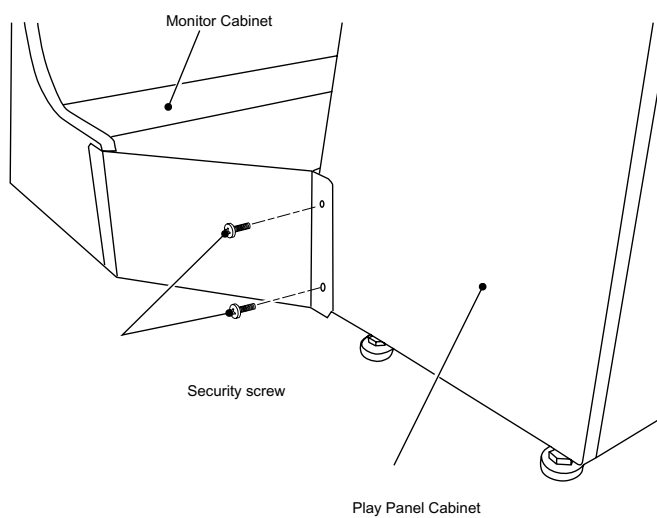

3-2 Fitting the Play Panel

1. Place the Play Panel assy onto the Play Panel Cabinet and connect the connector.

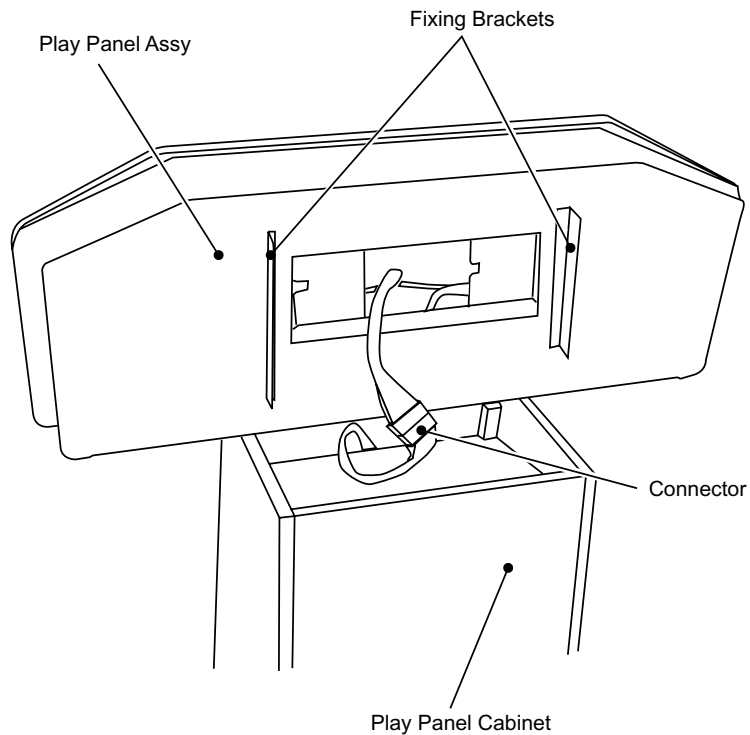

2. Fit the Play Panel assy in position on the Play Panel Cabinet, taking care not to trap any wires.
3. Fit the 4off Security screws to retain the Play Panel in place.

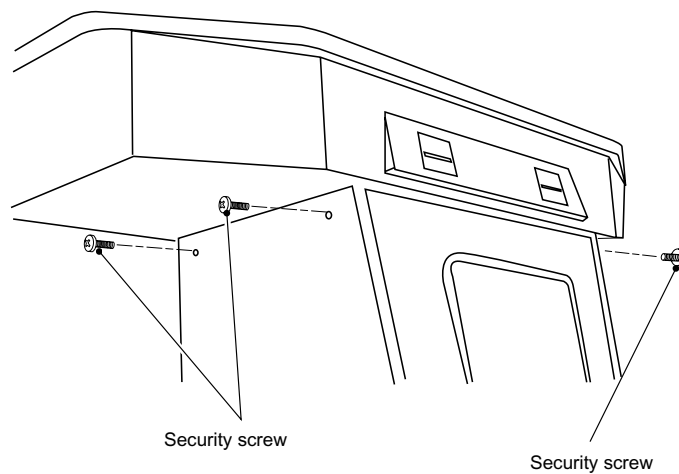

3-3 Fitting the Pop Header

1. Fit the Fixing Brackets to the top of the Monitor cabinet with 4 off Security screws.

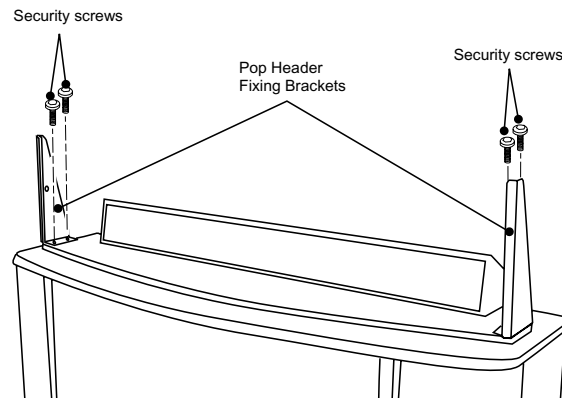

2. Slide the Pop Header into the Fixing Brackets from the top.

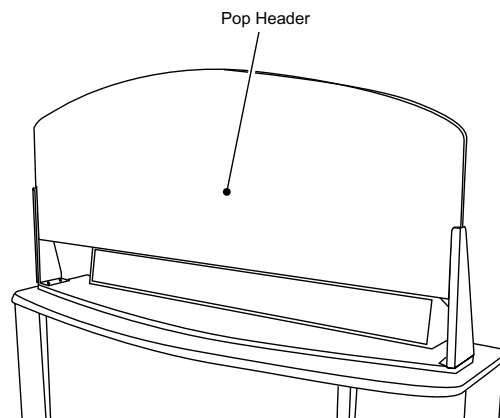

3. Tighten the 2 off security screws to retain the Pop Header in position
Note: Do not over-tighten the screws to avoid cracking the Pop Header.

3-4 Adjusting the Level Adjusters

1. When the game is in its final position lower the eight (8) (4off Monitor Cabinet 4off Play Panel Assy), Level adjusters, with a spanner, so that all castors are raised from the floor by approximately 5mm. Tighten the lock nuts with a spanner to ensure that the Level Adjusters do not move.

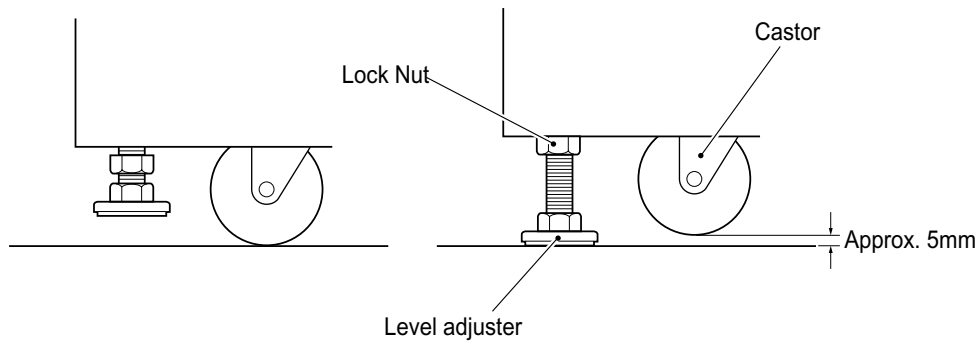

Note: If the site of this game has a smooth or polished floor, it is recommended that rubber pads are fitted under the Level Adjusters to prevent the game sliding on the floor when in use.

3-5 Installing the Cards

1. Remove the Weight from the dispenser.

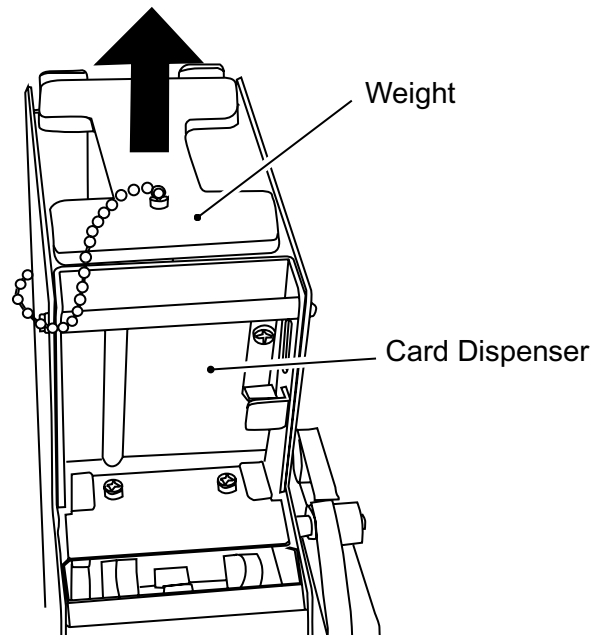

2. Insert cards into the dispenser making sure that all cards are laying flat.
Note: *Leave at least 10mm between the top card and the top of the dispenser to allow for the Weight.*

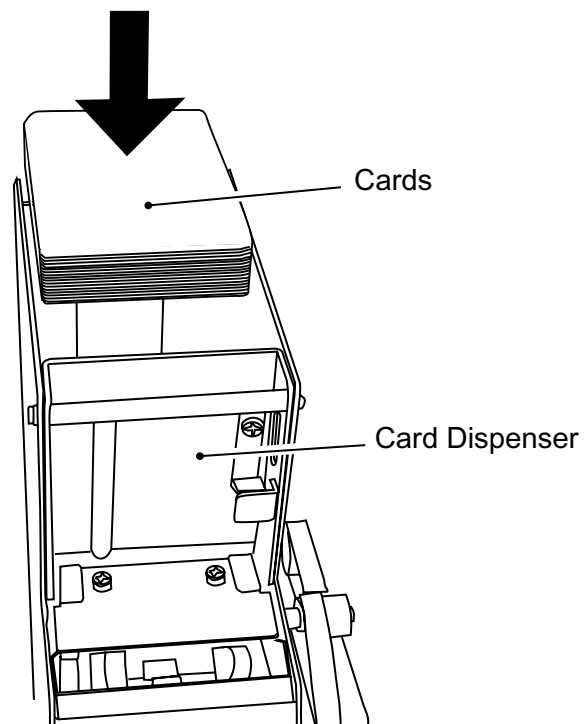

3. Replace the Weight.

3-6 Installing the CD-ROM

- The DVD-ROM Disc must be inserted with the power switched on. To prevent an electric shock, accident or injury, do not touch any parts other than those specified below.
 - The supplied DVD-ROM Disc is designed exclusively for this product. Never use the DVD-ROM Disc in any other product. Do not insert other DVD-ROM Discs in the DVD-ROM drive of this game.
 - The DVD-ROM tray retracts automatically after 10 seconds.
1. Press the eject button of the CD-ROM drive to open the tray.

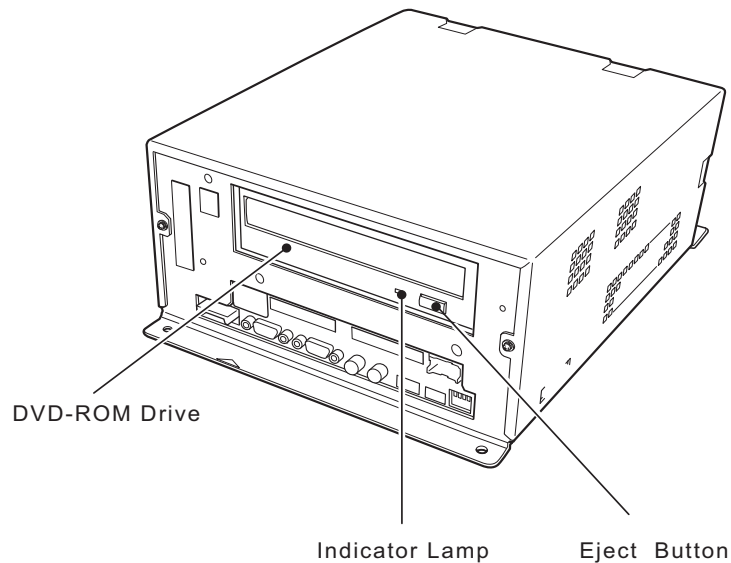

2. Place the DVD-ROM Disc on to the tray, ensuring that the label side (printed surface) is facing away from the Tray.

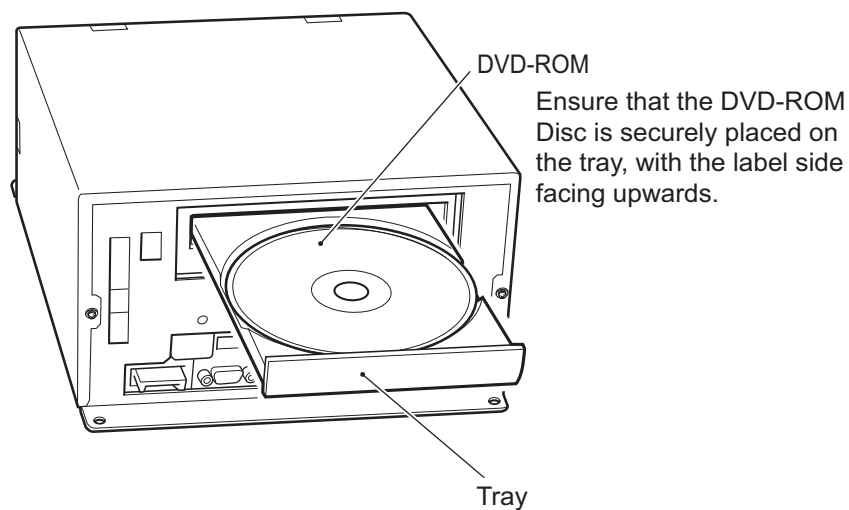

3. Press the Eject button to retract the Tray in to the unit.
4. Switch the power OFF, wait approx 10 seconds then switch the game back ON.

4. ADJUSTMENTS AND SETTINGS

The Game PC Board Assy is fitted with 4 Option Switches.

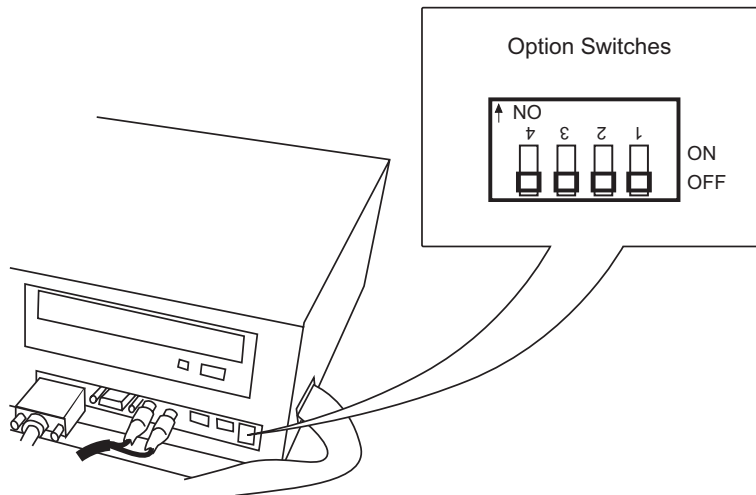

The JAMMA (B) PCB has the Volume Control fitted.

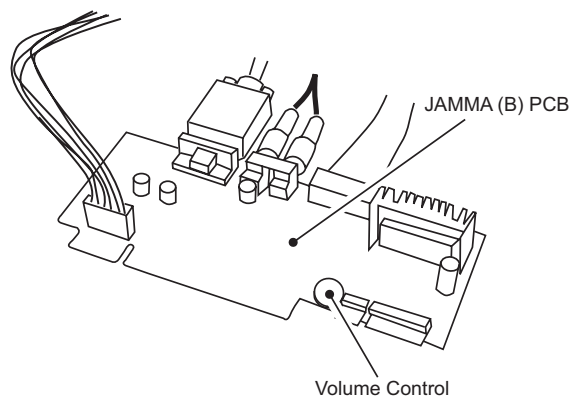

4-1 Option Switches

Switch 1 is used to change between Test Mode and Game Mode.

ON: Test Mode OFF: Game Mode

Switch 2 is used to set the output level of the video signal.

31kHz ON: 0.7V p-p OFF: 0.7V p-p
15kHz ON: 3.0V p-p OFF: 0.7v P-P

Switch 3 is used to change the monitor Sync Frequency

ON: 31kHz OFF: 15kHz

Note: When using a 31kHz monitor, set the RGB input of the monitor to 0.7v. If the monitor does not have a setting adjustment, refer to page 17 section 6-2-1 "Display Test", and change the Contrast and RGB Brightness levels to adjust the brightness.

Switch 4 is used to set the Video Sync Signal

ON: Composite Sync OFF: Seperate Sync

4-2 Test Mode

To enter Test Mode set the Test switch in the cabinet (if fitted) to ON, or if no Test switch is fitted to the cabinet, set Option switch 1 ON

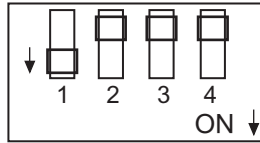

Note: The test mode is activated only when the cabinet Test switch or Option switch 1 is moved from OFF to ON. If the game is switched on with either switch in the ON position the Test Mode will not be activated. The switch must be switched OFF and then ON to enter the test mode.

When the Test Mode is entered, the following screen is displayed. Use the Joystick Up or Down to step through the tests. (The selected test will be displayed in red)

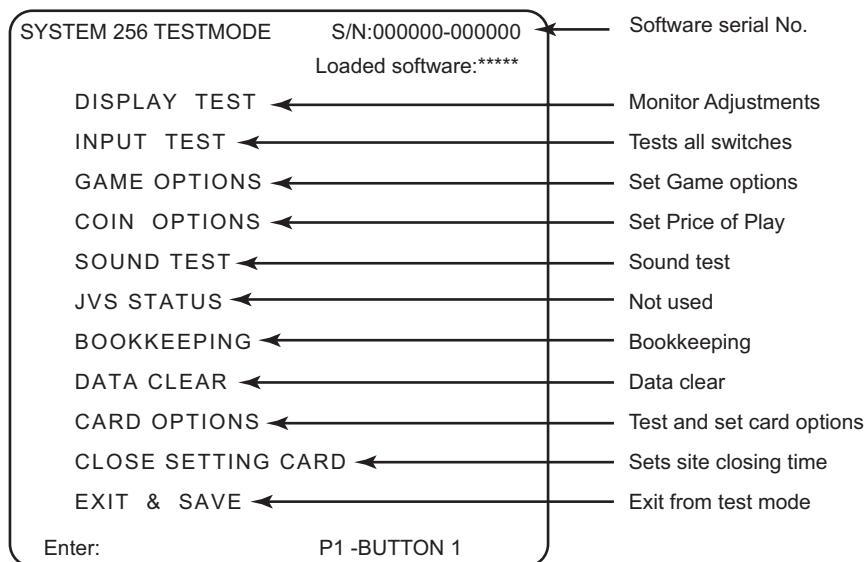

Press the 1 Player Button 1 to enter the selected test.

After making adjustments select EXIT and press the 1 Player Button 1 to return to the above screen. Select another test or select 'EXIT & SAVE' and press the 1 Player Button 1 to save the changes and return to the Game Mode.

Note: If 'EXIT & SAVE' is not selected and activated, any changes made may not be stored properly. Switching the cabinet Test switch or Option 1 switch OFF does not exit the Test Mode.

Switch the cabinet Test switch or Option 1 switch OFF.

4-2-1 Display Test

This test allows the following checks and adjustments to be made.

- Colour Edit
Adjust contrast and brightness of each colour to match video output from the PCB to the Monitor.
Note: This adjustment should only be made if the correct picture quality cannot be achieved by using the normal monitor adjustments.
- Convergence
Check and adjust the size, position and distortion of the screen image.

1. Select display Test from the Test Menu Screen, the following screen is displayed.

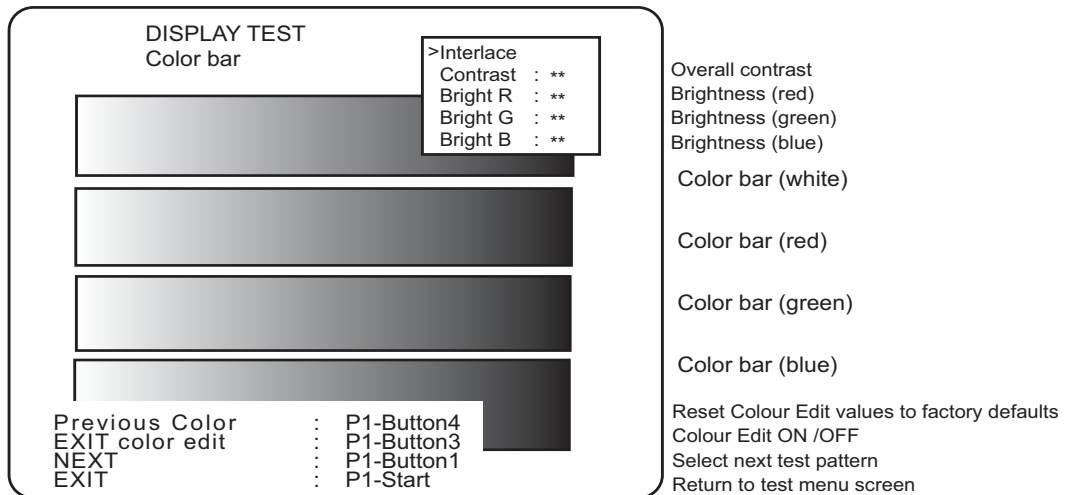

2. Each time the 1P Button 3 is pressed the Colour Edit adjustment box is turned ON or OFF.

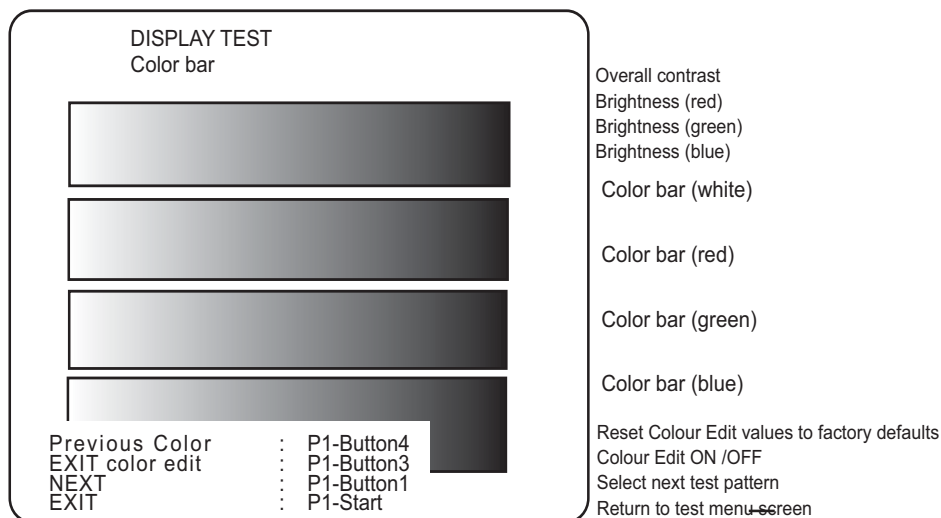

3. Press the 1P Button 1 to step to the next test function
COLOUR BAR → CONVERGENCE ↩

4-2-2 Colour Edit

1. Ensure that the Colour Edit Adjustment Box is showing. (Press P1 Button 3 if the Adjustment box is not displayed).
2. Use the Joystick UP/DOWN to step to the required adjustment. (Contrast, Brightness (red), Brightness (green), Brightness (blue)).
3. Use the Joystick LEFT/RIGHT to adjust the value.
3. When all adjustments have been made, press P1 Button 1 to step to the Convergence Test or P1 Start Button to return to the Main Test Menu screen

4-2-3 Convergence

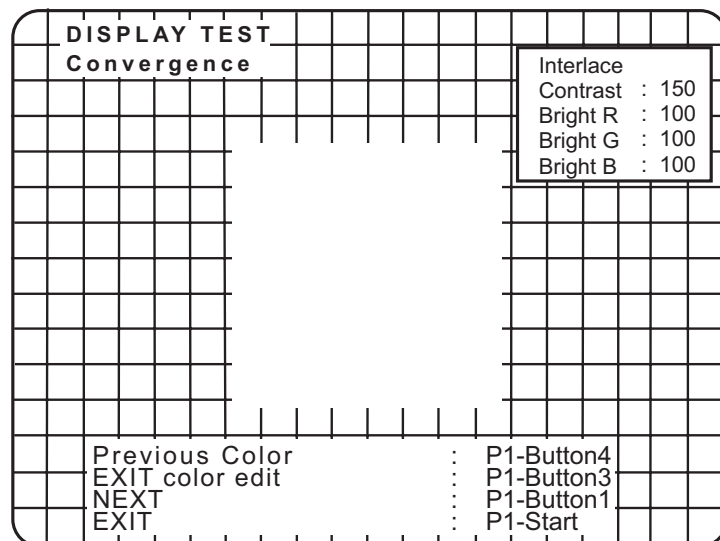

Use this screen to adjust the geometry (height, width , etc.) of the Monitor.

The screen colour will change each time P1 Button 4 is pressed.
When all adjustments have been made, press P1 Button 1 to return to the Colour Bar Screen or P1 Start Button to return to the Main Test Menu screen.

4-2-4 Input Test

Select Input Test from the Main Test Menu. The following screen is displayed.

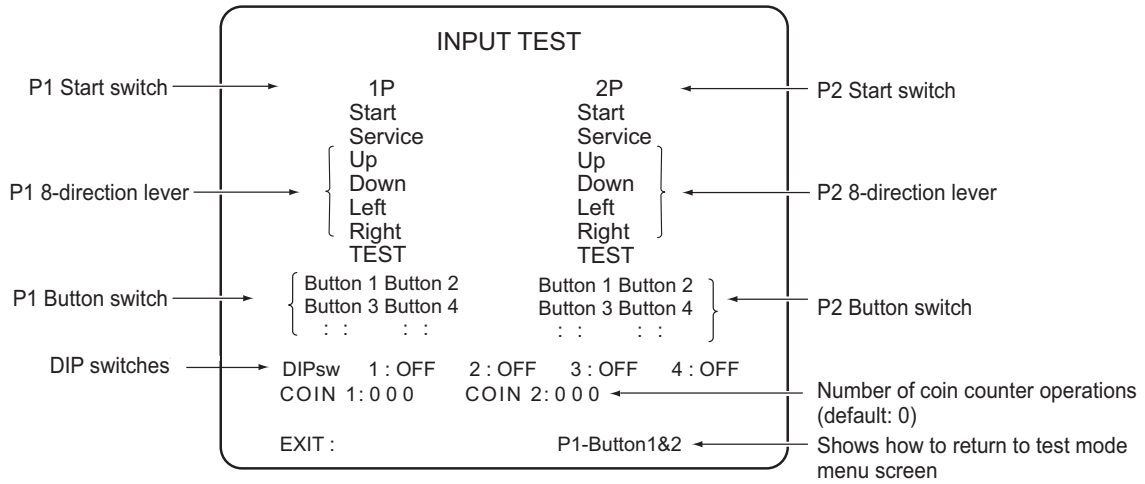

Each time a switch is operated, the corresponding item on the display will change colour to red, except the DIP switches which show whether the switch is ON or OFF.

When testing is completed, press P1 Buttons 1 and 2 together to return to the Main Test Menu screen.

4-2-5 Game Options

1. Select Game Options from the Main Test Menu. The following screen is displayed.

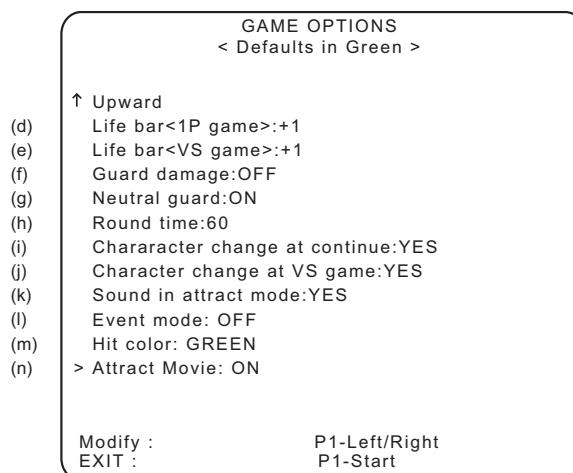
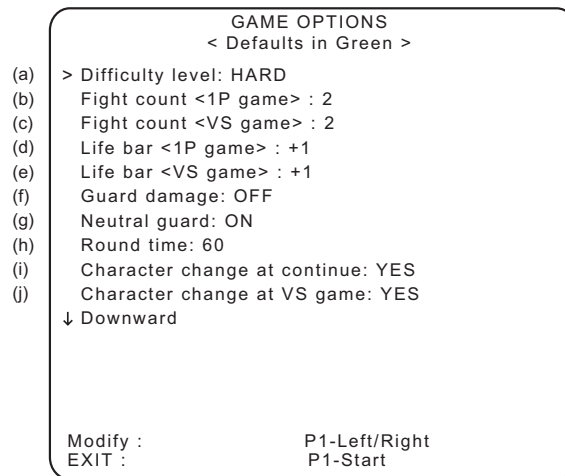

2. Use the Joystick UP/DOWN to step to the required adjustment.
3. Use the Joystick LEFT/RIGHT to adjust the value.
4. When all adjustments have been made, press P1 Start Button to return to the Main Test Menu screen

(a) Difficulty level (degree of game difficulty)

EASY	MEDIUM	HARD	VERY HARD	ULTRA HARD
------	--------	------	-----------	------------

(b) Fight Count <1P game > (number of rounds required to win the game in 1 player mode)

1	2	3	4	5
---	---	---	---	---

(c) Fight Count <VS game > (number of rounds required to win the game in 2 player mode)

1	2	3	4	5
---	---	---	---	---

(d) Life bar <1P game > (energy guage in 1 player mode)

-2	-1	NORMAL	+1	+2
----	----	--------	----	----

(e) Life bar <VZ game > (energy guage in 2 player mode)

-2	-1	NORMAL	+1	+2
----	----	--------	----	----

(f) Guard damage (damage received on guard)

ON (OFF
------	-----

(g) Neutral guard (guard activated with lever in neutral)

ON	OFF
----	-----

(h) Round time (time [seconds] per round)

30	40	60	80	99
----	----	----	----	----

(i) Character change at continue (change of character for continued game)

YES (possible)	NO (not possible)
----------------	-------------------

(j) Character change at VS game (change of character when another player joins in) see note

YES (possible)	NO (not possible)
----------------	-------------------

(k) Sound in attract mode

YES (with sound)	NO (without sound)
------------------	--------------------

(l) Event mode (action after 2 player game has finished)

ON	OFF
----	-----

(m) Hit colour (colour of graphic effects when attacks are successful)

RED	YELLOW
-----	--------

(n) Attract Movie (movie shown in attract mode)

OFF	ON
-----	----

Note: When card is used, the game character cannot be changed even if the setting (j) has been set to YES.

4-2-6 Coin Options

1. Select Coin Options from the Main Test Menu. The following screen is displayed.

COIN OPTIONS	
Defaults in Green	
(a)	> Start cost: 1Credit to START
(b)	Continue cost: 1Credit to CONTINUE
(c)	Coin chute 1 mechanical value: 1Coin count as 1coin
(d)	Coin chute 2 mechanical value: 1Coin count as 1coin
(e)	Credit mode: COMMON
(f)	Coin counter: 1counter
(g)	Free play: NO
Modify :	P1-Left/Right
EXIT :	P1-Start

2. Use the Joystick UP/DOWN to step to the required adjustment.
3. Use the Joystick LEFT/RIGHT to adjust the value.
4. When all adjustments have been made, press P1 Start Button to return to the Main Test Menu screen

Note: When using a CashFlow acceptor ensure that Cost and Coin Chute values are set to 1

- (a) Start cost (number of credits to start a game)

1	2	3	4	5	6	7	8	9
---	---	---	---	---	---	---	---	---

- (b) Continue cost (number of credits to continue a game - must be equal to or smaller than start cost)

1	2	3	4	5	6	7	8	9
---	---	---	---	---	---	---	---	---

- (c) Coin chute 1 mechanical value (number of credits for each coin)

1	2	3	4	5	6	7	8	9
---	---	---	---	---	---	---	---	---

- (d) Coin chute 2 mechanical value (number of credits for each coin)

1	2	3	4	5	6	7	8	9
---	---	---	---	---	---	---	---	---

- (e) Credit Mode (credit storage and use)

COMMON	EACH ONE
Credits are stored as a single account regardless of which coin switch or start switch is operated.	Different credit accounts are established. Credits from coin 1 are used by player 1 and credits from coin 2 are used by player 2

- (f) Coin counter (assignment of coin meters)

1 COUNTER	2 COUNTERS
Both coin switches share one coin counter	Each coin switch has its own coin counter

- (g) Free play

YES (no coins required)	NO (coins required)
-------------------------	---------------------

4-2-7 Sound Test

1. Select Sound Test from the Main Test Menu. The following screen is displayed.

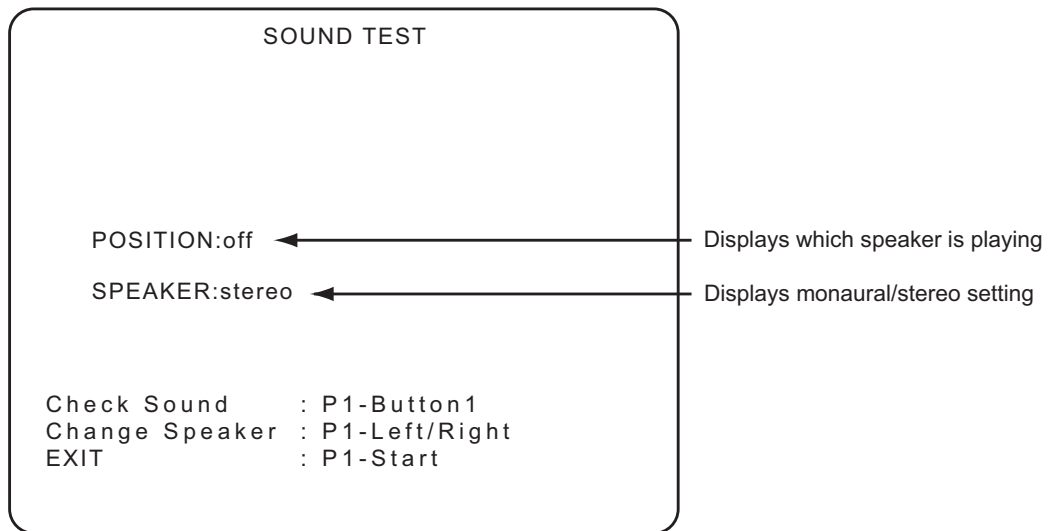

2. Press 1P Button 1 to conduct a stereo check. Sound will be produced from the left speaker only, then the right speaker only, then both speakers together. The display will show which speaker is active.
3. Use the Joystick LEFT/RIGHT to change between STEREO/MONO sound.
4. When testing has been completed, press P1 Start Button to return to the Main Test Menu screen

4-2-8 JVS Status

This test is inactive and not used on JAMMA system cabinets, it is only operational on JVS system cabinets.

4-2-9 Bookkeeping

1. Select Bookkeeping from the Main Test Menu. The following screen is displayed.

Bookkeeping		ON TIME	0:00:00
Coin 1 Total	0	Play Ratio	0%
Coin 2 Total	0	1P Play Ratio	0%
Service Total	0	VS Play Ratio	0%
Freeplay Total	1		
	Total Time	Count	Average
1P Play	0:00:00	000	0:00:00
1P Cont.	0:00:00	000	0:00:00
VS Play	0:00:00	000	0:00:00
All Play	0:00:00	000	0:00:00
Next:		P1-Button1	
Exit :		P1-Start	

Bookkeeping		ON TIME	0:00:00	
CHARACTER DATA				
	Rate	Total	1P	VS
RAVEN	0%/	0 /	0 /	0
FENG	0%/	0 /	0 /	0
ASUKA	0%/	0 /	0 /	0
PAUL	0%/	0 /	0 /	0
JIN	0%/	0 /	0 /	0
LAM	0%/	0 /	0 /	0
KING	0%/	0 /	0 /	0
YOSHIMITSU	0%/	0 /	0 /	0
NINA	0%/	0 /	0 /	0
HWOARANG	0%/	0 /	0 /	0
↓	Downward			
Next:		P1-Button1		
Exit :		P1-Start		

Bookkeeping		ON TIME	0:00:00	
VS GAME WINNING AVERAGE DATA				
	WinAve	Total	Win	LoseVS
RAVEN	0%/	0 /	0 /	0
FENG	0%/	0 /	0 /	0
ASUKA	0%/	0 /	0 /	0
PAUL	0%/	0 /	0 /	0
JIN	0%/	0 /	0 /	0
LAM	0%/	0 /	0 /	0
KING	0%/	0 /	0 /	0
YOSHIMITSU	0%/	0 /	0 /	0
NINA	0%/	0 /	0 /	0
HWOARANG	0%/	0 /	0 /	0
↓	Downward			
Next:		P1-Button1		
Exit :		P1-Start		

Item	Description
COIN1 TOTAL	Total number of coins inserted
COIN2 TOTAL	Total number of coins inserted
SERVICE TOTAL	Number of times the Service switch was pressed
FREEPLAY TOTAL	Number of free play games
PLAY RATIO	Percentage of play hours in total power ON hours (Rounded to one decimal place)
1P PLAY RATIO	Percentage of single player play hours in total
VS PLAY RATIO	Percentage of tournament mode play hours in total
TOTAL TIME	Total play hours
COUNT	Number of game plays
AVERAGE	Average play time
CHARACTER DATA	Number of times each game character was selected by players, and percentage in total
VS GAME WINNING AVERAGE DATA	Number of times each game character was selected by players for tournament game, and percentage of wins

4-2-10 Data Clear

1. Select Data Clear from the Main Test Menu. The following screen is displayed.

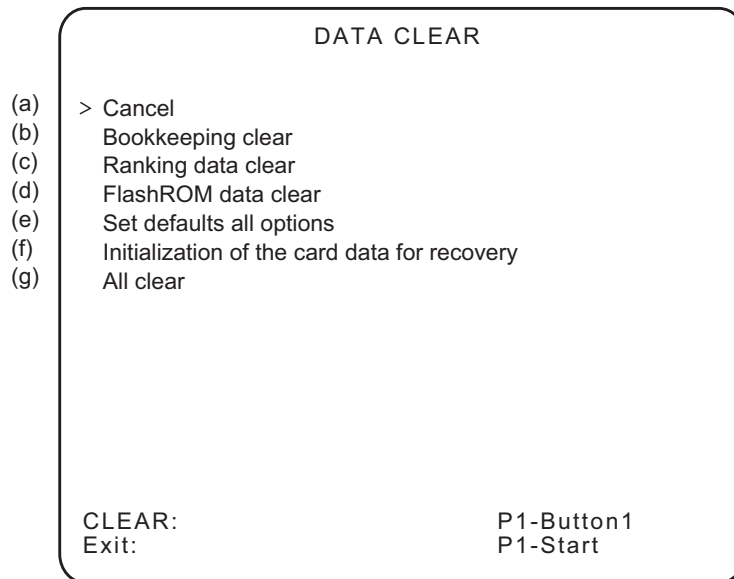

2. Use the Joystick UP/DOWN to step to the required adjustment.
 3. When all adjustments have been made, press P1 Start Button to return to the Main Test Menu screen
- (a) Returns to the Main Test Menu.
 - (b) Resets all Book Keeping data to zero.
 - (c) Resets the record of consecutive wins.
 - (d) Initializes the data stored in the flash memory, such as ghost data and replay data.
 - (e) Resets all Game and Coin Options to factory default.
 - (f) Deletes the information for card data restoration.
 - (g) Returns ALL data and settings to defaults.

4-2-11 Card Options

This test is used to set the Read/Write unit and TEKKEN-NET IDcard.

1. Select Card Options from the Main Test Menu. The following screen is displayed.

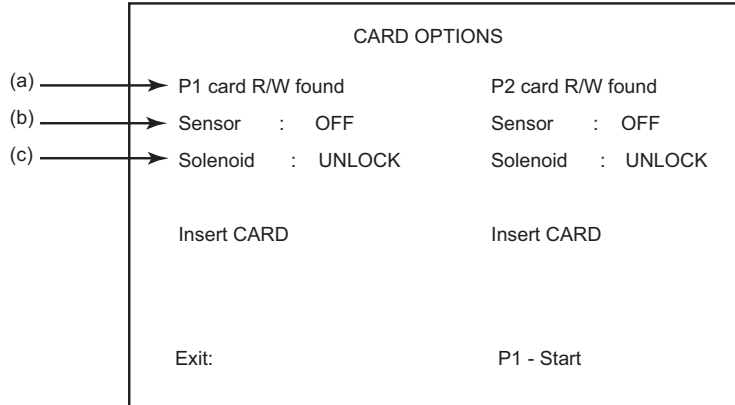

Item	Options	Description
(a) P1 card R/W found (P2 card R/W found)	[found] or [not found]	Displays [found] if the card R/W unit is connected to the Game PC board, and displays [not found] if it is not connected.
(b) Sensor	[ON] or [OFF]	Displays [ON] when a card is inserted in the card R/W unit, and displays [OFF] when there is no card in the card R/W unit
(c) [UNLOCK] or [LOCK]	[UNLOCK] or [LOCK]	As soon as the card is inserted into the card R/W unit, the card is locked into position and the screen displays "LOCK". If the card is not locked in position, the screen displays "UNLOCK"

2. To conduct a test or data restoration, insert a card into the Read/Write unit

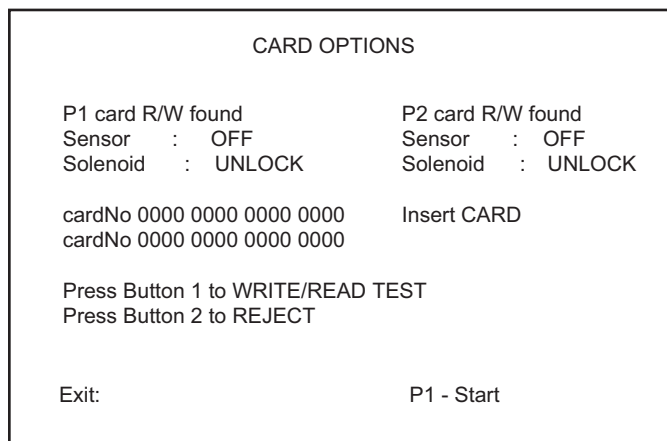

** Note: The above is an example of the screen display when two cards are inserted into the P10-side card R/W unit*

Display after card insertion

Item	Description
CardNo 0000 0000 0000 0000 CardNo 0000 0000 0000 0000	When a card is inserted in the card R/W unit, the 16-digit number (access code) printed on the reverse of the inserted card is displayed on the screen. When two cards are inserted, the access codes for both cards are displayed in two rows

If a card is inserted in the P1-side card R/W unit, press the P1 Button switch 1 to conduct the card read/write test. If a card is inserted in the P2-Side card R/W unit, press the P2 Button switch 1 to conduct the card read/write test. To eject the card from the card R/W unit, press the Button switch 2 on the side in which the card is inserted.

CARD OPTIONS	
P1 card R/W found	P2 card R/W found
Sensor : OFF	Sensor : OFF
Solenoid : UNLOCK	Solenoid : UNLOCK
READ DATA ERROR	Insert CARD
cardNo 0000 0000 0000 0000	
Press Button 1 to WRITE/READ test	
Press Button 2 to REJECT	
Press Button 3 to Restore Data *Note 1	
Exit:	P1 - Start

** Note 1: This item is only shown when an error card is inserted*

Item	Description
CARD READ ERROR	This indicates that a card other than a TEKKEN-NET ID card was inserted and data could not be read.
CARD WRITE ERROR	This indicates that the Write test has failed.
READ DATA ERROR	This indicates that comparison of the data after the write test resulted in a mismatch.
WRITE READ OK	This indicates that both read and write operations were successful.

** Note 1: Conducting the card read/write test will not damage the game play data on the card.*

** Note 2: When two cards are inserted, the card read/write test cannot be performed.*

If a card on which a write error was generated is inserted or if a card on which data was destroyed due to power-off during data writing is inserted, pressing the Button switch 3 of the applicable player side initiates an attempt to restore the data on the card.

Card data may or may not be restored depending on the condition of the card, as described below.

- Data may only be restored with the card that was used to play the game with the Game PC board that you are working on and has been set to the test mode. It should be noted that there is a limit to the amount of data saved (10 cases max.).
- If a write error was indicated during a game play, it may be possible to restore the data successfully.
- If power interruption occurred when data was being written to the card, it may be possible to restore the data successfully.
- If the card was pulled out during a game play, the data cannot be restored.
- Data restoration can be tried only once for one error.
- Data restoration cannot be conducted with a card whose access code is different from the data stored in the cabinet.
- Data cannot be restored with a card which disallows data reading or writing due to damage.

To return to the test menu screen, press P1 Start switch.

4-2-12 Close Setting

This mode is used to set the site closing time, and prevents the card from being used from 15 minutes before the set time. This ensures that data is not lost if the game is powered-down during game play.

The time can be set between 19:00 and 31:00 (7:00 am on the following day), or 24 hour operation.

The same closing time can be set for every day, or the the closing time can be set differently for each day of the week.

1. Select Close Setting from the Main Test Menu. The following screen is displayed.

CLOSE SETTING
Defaults in Green

>Time Setting:2004/10/04 (MON) 19:00 ← (a)

Schedule type : DAY ← (b)

Hours : 24 ← (c)

Minutes : 24 ← (d)

Modify: P1-Left / Right
Exit: P1 - Start

Close Setting screen (Day)

CLOSE SETTING
Defaults in Green

>Time Setting:2004/10/04 (MON) 19:00 ← (a)

Schedule type : WEEK ← (b)

(SUN) Hours:24 ← (c) (SUN) Minutes:00 ← (d)

(MON) Hours:24 (MON) Minutes:00

(TUE) Hours:24 (TUE) Minutes:00

(WED) Hours:24 (WED) Minutes:00

(THU) Hours:24 (THU) Minutes:00

(FRI) Hours:24 (FRI) Minutes:00

(SAT) Hours:24 (SAT) Minutes:00

Modify: P1-Left / Right
Exit: P1 - Start

Close Setting screen (Week)

2. Use the joystick Up/Down to scroll through the options and the joystick Left/Right to change the settings.

Item	Setting Options	Default	Description
(a) TIME SETTING			Set the current time
(b) SCHEDULE TYPE	[DAY]<=>[WEEK]	[DAY]	Select daily setting [DAY] or weekly setting [WEEK]. *note 1
(c) HOURS	[24]>=>[25]>=>[26]>=>[27]>=>[28]>=>[29]>=>[30]->=>[31] [ALLDAY]>=>[19]>=>[20]>=>[21]>=>[22]>=>[23]->=>[24]	[ALLDAY]	Set the [HOURS] for closing time setting. Select [ALLDAY] if the machine is made available 24 hours of the day.
(d) MINUTES	[00]>=>[15]>=>[30]>=>[45]>=>[008]>=>....	[24HOURS]	Select [MINUTES] for closing time *note 2

*Note 1: When [DAY] is selected, the same closing time applies to every day of the week, and the machine disallows the use of card 15 minutes before the set closing time.

The machine begins accepting cards from 7:00am, except when [ALL DAY] is set.

*Note 2: When [HOURS] is set to [30], the [MINUTES] indication becomes fixed at [00]. When [ALL DAY] is set, "(24 HOURS)" is indicated.

Example: When [HOURS] and [MINUTES] are set to [25] and [30], respectively, the daily closing time will be 1:30am, and the machine will stop accepting cards at 1:15am.

Select "Time Setting" and press the P1 Button switch to display the time setting screen shown below.

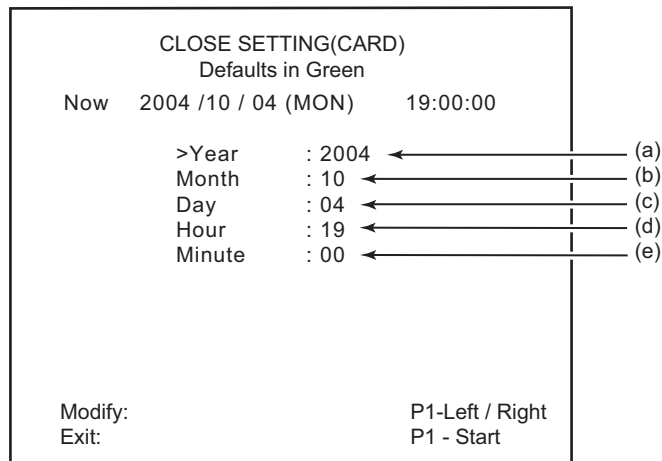

Close Setting screen (Time Setting)

Item	Setting Options
(a) YEAR	Set the current Year.
(b) MONTH	Set the current Month.
(c) DAY	Set the current Day.
(d) HOURS	Set the Hours of the current time.
(e) MINUTES	Set the Minutes of the current time.

* Note: The day of the week is automatically displayed when the [DAY] setting is entered.

To return to the test menu screen, press the P1 Start switch.

5. MAINTENANCE AND ADJUSTMENTS

5-1 Replacing the Push Button Switch

1. Remove 5 off security screws and lift the Panel assy up and forward.

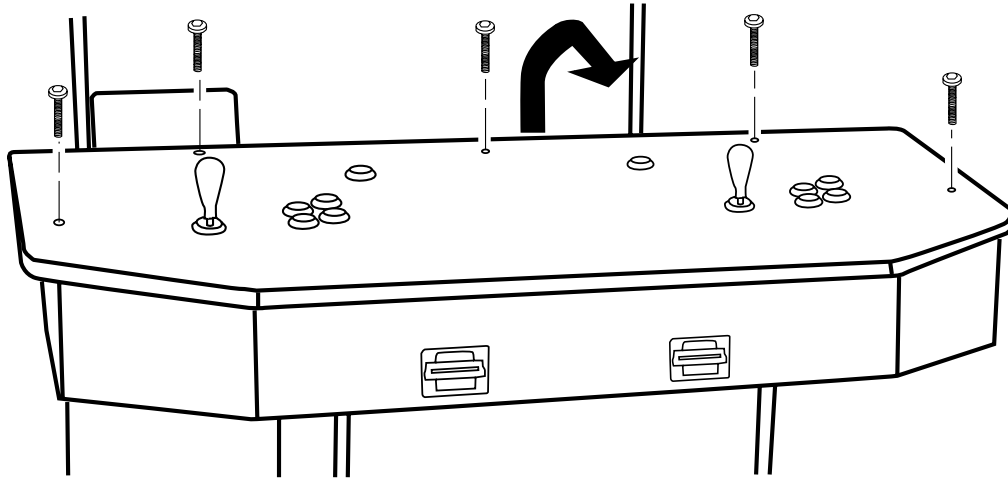

2. Disengage the lug of the long retaining arm from the microswitch, lift the front of the switch up, and remove from the switch holder.
3. Reassemble in reverse order.

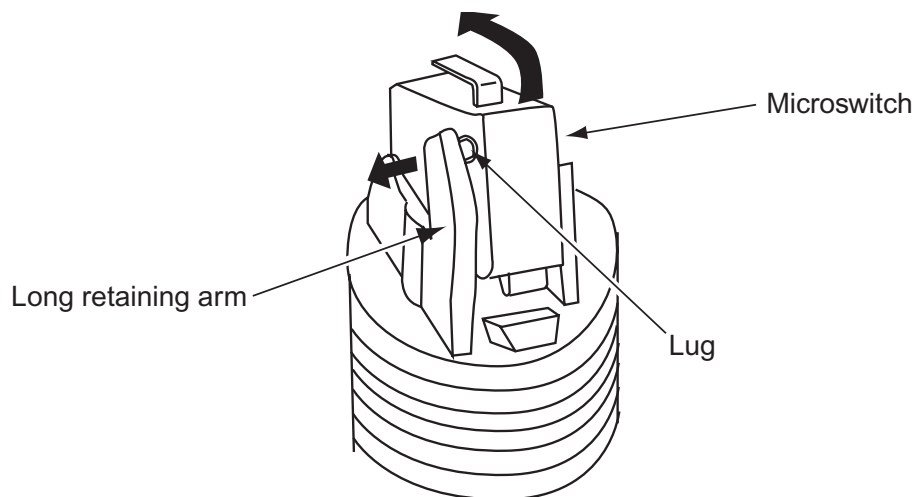

5-2 Replacing the Joystick Assy

1. Open the Play Panel. (see 5-1 (1) page 53)
2. Disconnect the connectors from the Joystick switches.
(Note the positions and colours of the wires to ensure that they are reconnected to the same terminals.)
3. Remove the circlip from the base of the joystick shaft.

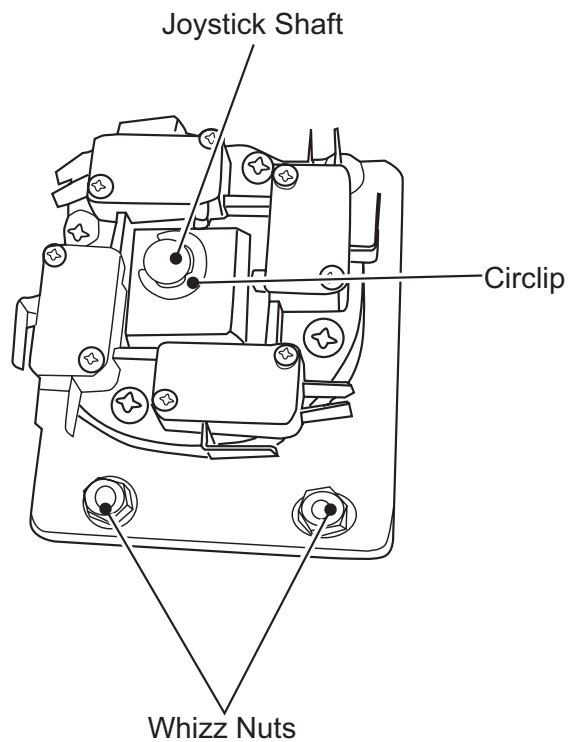

4. Withdraw the Joystick Shaft from the front of the Play Panel.
5. Remove 4off whizz nuts and remove the Joystick Assy.
6. Reassemble in reverse order.

6. PARTS

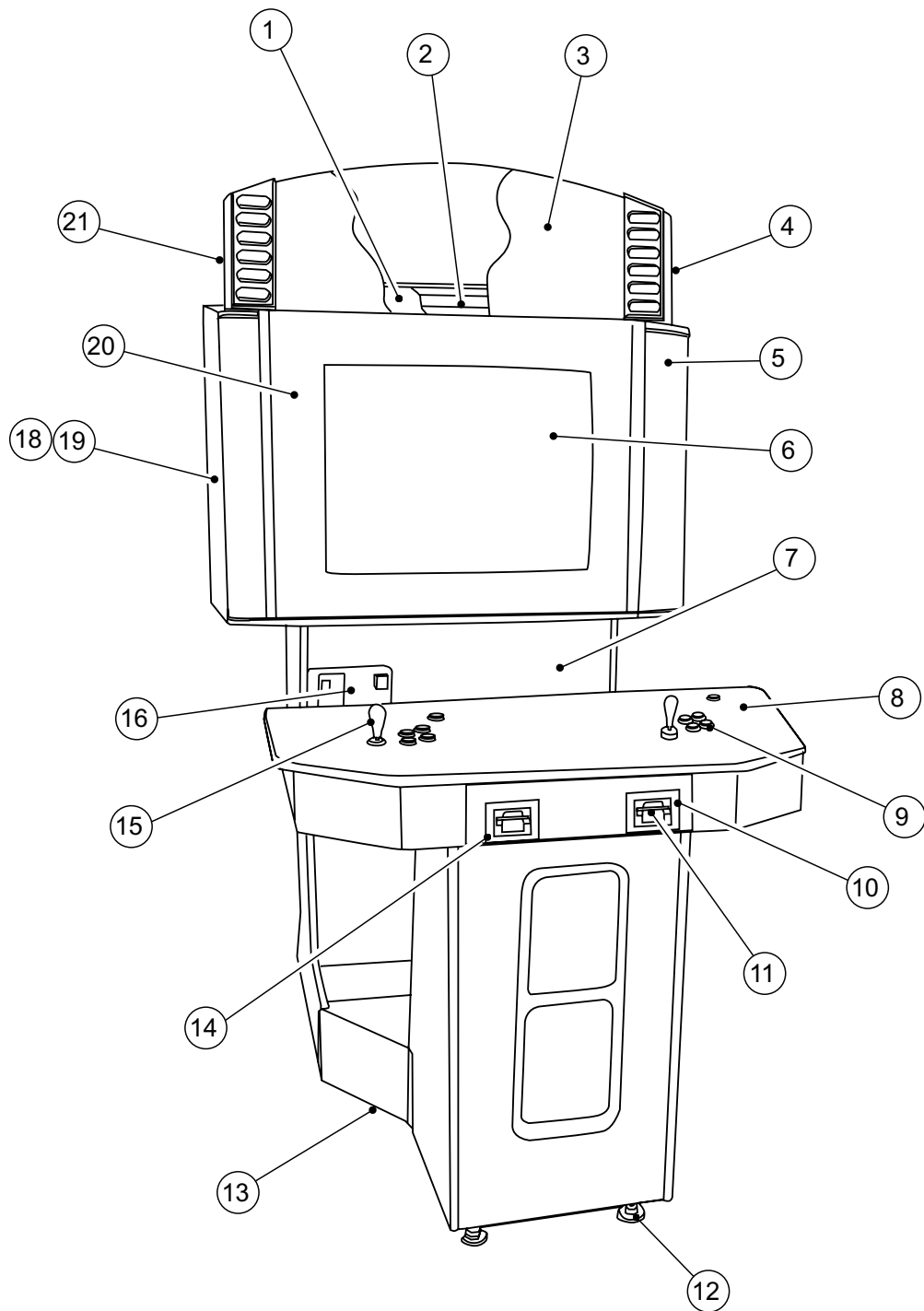

Item	Description	Part No
1	Fluorescent Acrylic Cover	XTEC5-NT510PB
2	Fluorescent Assy	XTEC5-07RF
3	Tekken 5 Showcase Acrylic	30000094
4	Acrylic Fixing Brkt - RHS	XTEC5-NT513EBD
5	Speaker Grille	XTEC5-AM13GHP
6	Monitor	XTEC5-03H34PST
7	Monitor Cabinet Front Decal	40000820
8	Play Panel Decal	40000783
9	Pushbutton Switch Assy	XTEC5-06BPN
10	Card R/W Surround Decal - Player 2	40000818
11	Tekken 5 Card Read/Writer	XTEC5-CARDRWASSY
12	Adjustable Foot	XTEC5-6VL16x122
13	Castor	XTEC5-6RP105
14	Card R/W Surround Decal - Player 1	40000817
15	Joystick Assy	XTEC5-27JN
16	Card Dispense Decal	400000802
18	Tekken 5 Showcase LHS Decal	40000798
19	Tekken 5 Showcase RHS Decal	40000799
20	Monitor Plexi	XTEC5-NT510PE
21	Acrylic Fixing Brkt - LHS	XTEC5-NT513EBG

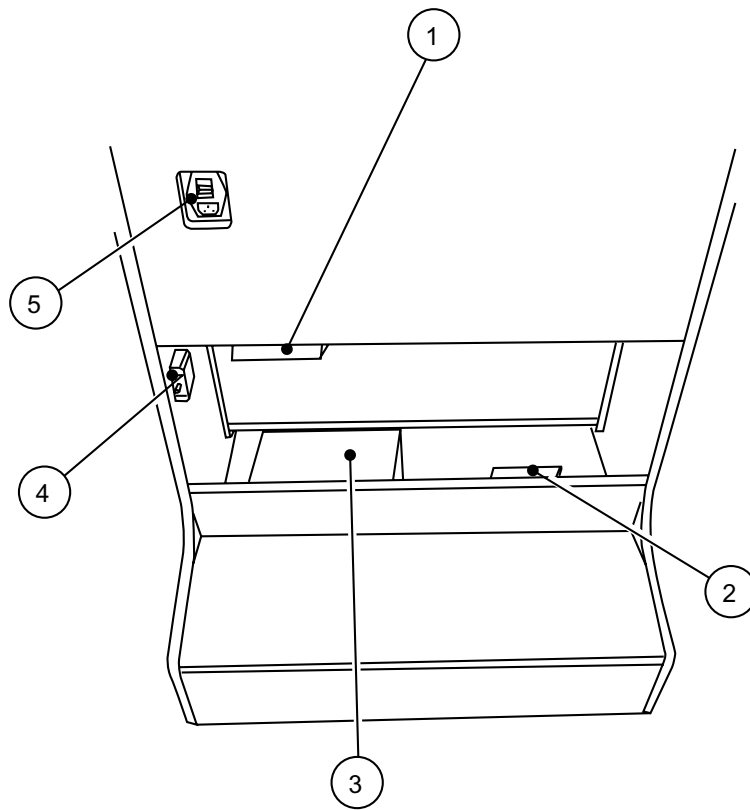

Item	Description	Part No
1	Switchmode Power Supply PW-200APSA	83000013
2	Jamma PCB Asst	XTEK4-JAMMA
3	Tekken 5 Game PCB Assy	XTEK5-RACKASSY
	Tekken 5 DVD-ROM	XTEK5-DVD
	Tekken 5 Security Dongle	XTEK5-DONGLE
4	Interlock Switch	60000006
	Interlock Switch Cover	39000028
5	Shaffner Mains Input Assy	62500010
	Shaffner Boot	66000017

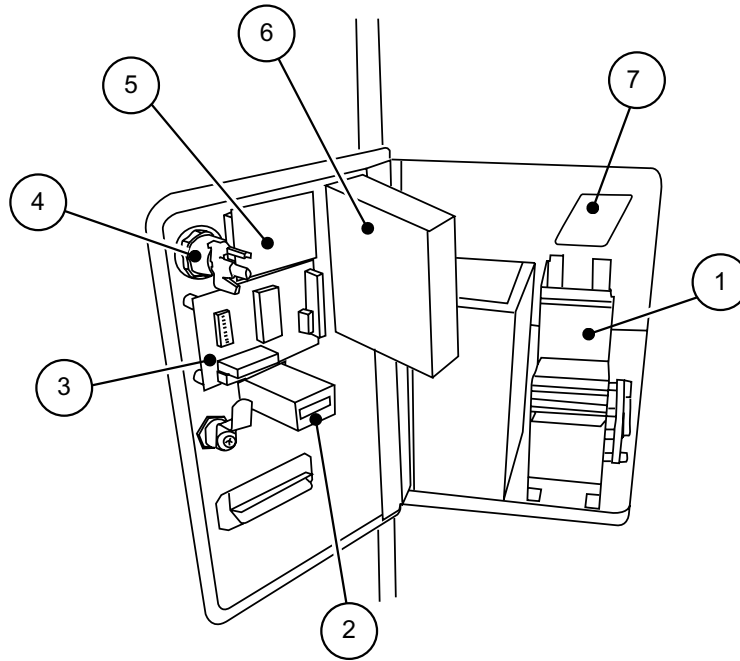

Item	Description	Part No
1	Card Dispenser Asahi Seiko CD-200 230mm	47000777
2	Panel Mount Meter 3.6-6VDC	65000002
3	Credit Control PCB	81000066
4	"Available When Lit" Button	60200010
5	2 Digit Display Assy	47000780
6	Cashflow 330 Coin Acceptor F/E D/P	65500754
7	Tekken 5 Card (pack of 50)	XTE5-306-000

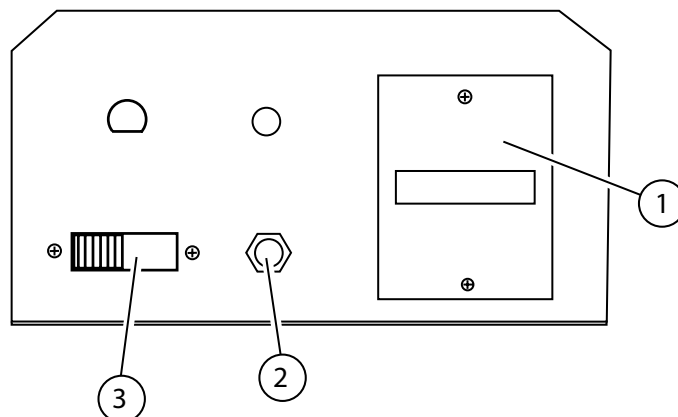

Item	Description	Part No
1	3.5-6VDC Panel Mount Meter	65000002
2	Service Switch 7mm Red F424	60000059
3	Miniature Slide Switch	60000023

Copies of Namco Game Manuals can be downloaded from our **website:**

www.namco.co.uk

They are located under Components, Sales and Service

For all Parts or Technical Support contact:

Brent Electronic,
Namco House,
Units 5-8, Acton Park Estate,
The Vale,
London. W3 7QE

www.brentelectronic.co.uk

For Technical Support, Warranty and

Advance Replacement Parts:-  +44 (0) 20 8324 6120

For Consumable Parts:-  +44 (0) 20 8324 6102

Fax for both:-  +44 (0) 20 8324 6126